

ORACLE®

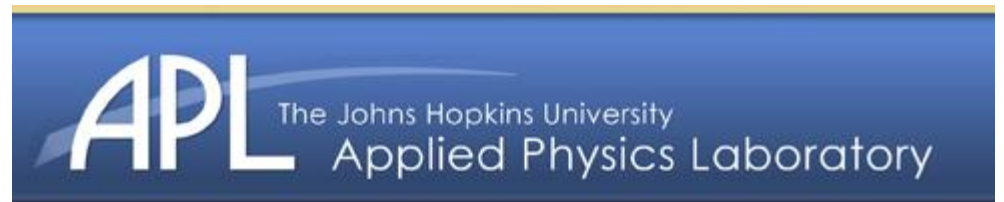

ORACLE®



Latest on Oracle Application Change Management Pack for Oracle E-Business Suite

Angelo Rosado, Oracle Senior Product Manager
Ray Payne, JHUAPL Principal Systems Architect

Program Agenda

- Application Change Management Solution
- Introduction to the new Application Management Suite
- Roadmap
- JHUAPL Case Study
- Related Sessions
- Q&A





Application Change Management Solution

SOFTWARE.
HARDWARE.
COMPLETE.



Quote Attribution

Raymond Payne, Principal Systems Architect,
Oracle Infrastructure, The Johns Hopkins
University Applied Physics Laboratory

“Our goal is to exploit the capabilities of Oracle Enterprise Manager to be the central orchestration point for all of the Oracle technologies we have deployed in our enterprise.

The addition of the Application Management and Application Change Management packs greatly extends the scope of our IT Process management capabilities, eliminating errors in deployment of patches, customizations, and configuration changes throughout our E-Business Suite installations, and has resulted in greater efficiency, repeatability, and security in these processes.”

Business Challenges

- Still applying customizations with homegrown tools?
- Still tracking patches across instances with spreadsheets?
- Still copying functional setups between environments by hand?
- Still having challenges enforcing segregation of duties?

Application Management Suite for Oracle E-Business Suite

Application Management Pack for Oracle E-Business Suite

System Management tools

- Centralized Management
- Proactive Monitoring
- Automated Cloning

Application Change Management Pack for Oracle E-Business Suite

Change Management tools

- Customization Manager
- Patch Manager
- Setup Manager

Application Change Management Solution for EBS

**Application Change
Management Pack**
for Oracle E-Business Suite

Application Management Pack
for Oracle E-Business Suite

**Oracle Enterprise Manager
Grid Control**

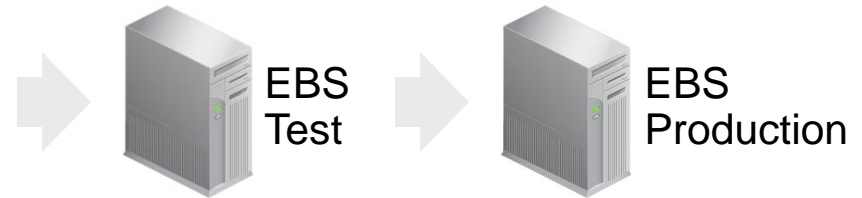

Automated deployment across different environments

- Oracle EBS patches
- Your own customized patches
- Functional setups

Application System Management Solution for EBS

Application Change
Management Pack
for Oracle E-Business Suite

Application Management Pack
for Oracle E-Business Suite

Oracle Enterprise Manager
Grid Control

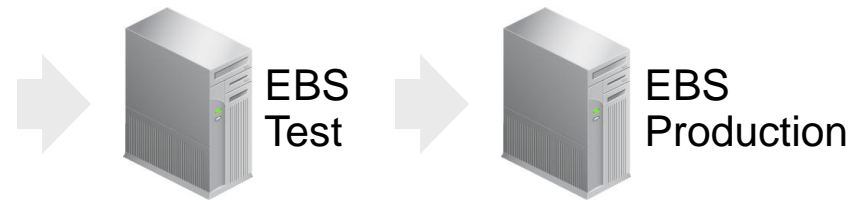

Centralized management of multiple environments

- Monitor concurrent requests, workflows, user sessions
- Report on history & trends
- Automate repetitive DBA tasks

Application Change Management Solution

Customization Manager

Customization Manager

Page Refreshed Apr 14, 2010 4:31:42 PM (UTC-05:00)

Packages

Search [Advanced Search](#)

Procedure Previous 1-10 of 21 Next 10

Select	Name	ID	Release	Product	Type	Status	Owner	Last Updated	Update	Delete
<input checked="" type="radio"/>	Demo 112	100000000344	R12	xxco	AOL	Succeeded	SYSMAN	Apr 7, 2010 2:10:26 PM (UTC-05:00)		
<input type="radio"/>	31 Test 2	100000000343	R12	xxco	AOL	Succeeded	SYSMAN	Apr 7, 2010 12:04:16 PM (UTC-05:00)		
<input type="radio"/>	31 Test	100000000340	R12	xxco	AOL	Succeeded	SYSMAN	Apr 1, 2010 3:34:09 PM (UTC-05:00)		
<input type="radio"/>	Angelo 45	100000000320	11i	xxco	Others	Succeeded	SYSMAN	Mar 10, 2010 6:33:31 PM (UTC-05:00)		
<input type="radio"/>	TEST KEB1	100000000300	R12	xxco	AOL	Succeeded	SYSMAN	Mar 5, 2010 11:55:15 AM (UTC-05:00)		
<input type="radio"/>	Iberdola	100000000280	R12	xxco	AOL	Succeeded	SYSMAN	Feb 25, 2010 6:44:06 PM (UTC-05:00)		
<input type="radio"/>	Rogers CM1	100000000260	R12	xxco	AOL	Succeeded	SYSMAN	Feb 23, 2010 3:50:58 PM (UTC-05:00)		
<input type="radio"/>	ICC CM 1	100000000240	R12	xxco	FORMS	Succeeded	SYSMAN	Feb 17, 2010 8:53:01 PM (UTC-05:00)		
<input type="radio"/>	CMS CM 1	100000000220	R12	xxco	AOL	Succeeded	SYSMAN	Feb 16, 2010 3:48:21 PM (UTC-05:00)		
<input type="radio"/>	Demo 200	100000000201	R12	xxco	AOL	Succeeded	SYSMAN	Feb 15, 2010 10:55:08 AM (UTC-05:00)		

Procedure Previous 1-10 of 21 Next 10

Related Links

[File Source Mapping](#)
[File Metadata Repository](#)

[E-Business Suite Mapping](#)
[Package Report](#)

[Custom Applications](#)
[Custom Application Requests](#)

- Build AD compliant custom patches
- Deploy on all your EBS instances using Patch Manager / AD Patch
- Create custom patches with prerequisite

- Manage custom patches through release life cycle (Succeeded, Released, Obsolete)
- Extensive reports - Standards, Package comparison, and Instance comparison

Application Change Management Solution

Customization Manager

Package Details

Package ID	100000000344	Status	Succeeded
Package Name	Demo 112	Product	xxco
Release	R12	Package Type	AOL
Standard Checker Result	Success	E-Business Suite Mapping Name	
Owner	SYSMAN	File Source Mapping Name	SC File Source Mapping
Created	Apr 7, 2010 2:02:37 PM (UTC-05:00)	Uploaded	No
Last Updated	Apr 7, 2010 2:10:26 PM (UTC-05:00)	Public	No

Description

[Return to Top](#)

Instructions

Readme

[Return to Top](#)

▼ Patch Downloads

[Return to Top](#)

File Name	Language	Size	Readme
p100000000344_Generic.zip	Generic	bytes69739 (.067MB)	

▼ Manifest

[Return to Top](#)

[Download Manifest](#) | [Locate File](#)

Product	Source Path	File Name	Language	Destination Path	Version	Last Updated
xxco	patch/115/import/US	CM_Concprog.Idt	US	patch/115/import		Apr 7, 2010 2:03:29 PM (UTC-05:00)
xxco	patch/115/import/US	CM_Menu.Idt	US	patch/115/import		Apr 7, 2010 2:03:29 PM (UTC-05:00)
xxco	patch/115/import/US	CM_ReqGroup.Idt	US	patch/115/import		Apr 7, 2010 2:03:29 PM (UTC-05:00)
xxco	patch/115/import/US	CM_Responsibilities.Idt	US	patch/115/import		Apr 7, 2010 2:03:29 PM (UTC-05:00)
xxco	patch/115/import/US	CM_User.Idt	US	patch/115/import		Apr 7, 2010 2:03:29 PM (UTC-05:00)
xxco	forms/US	FNDCPDCL.fmb	US	forms		Apr 7, 2010 2:03:29 PM (UTC-05:00)

TIP Table displays upto 200 records only

▶ Technology Stack Details

[Return to Top](#)

- Oracle standard checker for each file type
- Support for over 200 file types

- Each package provides complete details of the manifest, and more

Application Change Management Solution

Customization Manager

ORACLE Enterprise Manager 10g
Grid Control

Home Targets Deployments Alerts Compliance Jobs Reports

Oracle Applications | Hosts | Databases | Middleware | Web Applications | Services | Systems | Groups | All Targets

Customization Manager

Page Refreshed Dec 8, 2009 6:05:32 AM PST

Custom Applications

Search

Add

Application Short Name	Application Name	Created By	Last Updated	Details
xxnew	New Custom Application	SYSMAN	Dec 8, 2009 1:17:59 AM PST	Details
dem01	Team 01 Order Entry Demo	SYSMAN	Dec 7, 2009 2:46:42 PM PST	Details
cpgc	CPG - CDOA	SYSMAN	Dec 7, 2009 12:13:52 PM PST	Details
psr	Public Sector Receivables	SYSMAN	Dec 7, 2009 12:13:52 PM PST	Details
test	test	SYSMAN	Dec 7, 2009 12:13:52 PM PST	Details
ouc	University Curriculum	SYSMAN	Dec 7, 2009 12:13:52 PM PST	Details
csn	Call Center	SYSMAN	Dec 7, 2009 12:13:52 PM PST	Details
xxlok1	Lok1	SYSMAN	Dec 7, 2009 11:50:53 AM PST	Details
xxlok	Lok Test	SYSMAN	Dec 7, 2009 11:33:50 AM PST	Details
xxco	Consulting customization	SYSMAN	Dec 7, 2009 11:32:03 AM PST	Details

Add

Previous 1-10 of 13 Next 3

Related Links

[File Source Mapping](#) [Packages](#) [E-Business Suite Mapping](#)
[File Metadata Repository](#) [Package Report](#) [Custom Application Requests](#)

Automated creation and validation of custom application top

Application Change Management Solution

Patch Manager



Patch Oracle Applications: Patch Details

Cancel Save Back Step 3 of 7 Next

Target Stage Directory Location:
Directory where zipped patches are downloaded.

Target Patch Directory Location:
Directory location where patches are unzipped and applied from.

Download patches to the OMS:

OMS Stage Directory Location:
Directory where zipped patches are downloaded on the OMS.

Oracle E-Business Suite Updates

Select the Software Updates to apply. Click on "Add Oracle Patch" to search and select software updates from Metalink or "Add Custom Patch" to search and select custom patches from the OMS. Consult README to determine any necessary steps. Click on the icon in the README column to view the README.

Merge Patches

Patch ID	Product	Platform	Version	Description	Files	Order	Can Be Re-Applied	Pause After Patching	README	Tech Stack Report	Remove
6905879	OAM	Generic Platform	R12	ADD ICELANDIC, VIETNAMESE, AND SLOVENIAN TO ADLICMGR.INI IN R12	• p6905879_R12.OAM.A_R12_GENERIC.zip	1	<input type="checkbox"/>	<input type="checkbox"/>			
100000000344	xxco	Generic Platform	R12		• p100000000344_Generic.zip	1	<input type="checkbox"/>	<input type="checkbox"/>			

Add Oracle Patch Add Custom Patch Check Prerequisites

Remove All

TIP To lookup for the README, selected updates should be valid patch on Oracle Metalink and require connection to Oracle Metalink. To Setup or Update Oracle Metalink credentials click on the 'Setup' Link.

- Deploy EBS and custom patches in a single patch run
- Order patches or merge a set of patches

- Perform prerequisite patch checking
- An extensible Patch Manager deployment procedure

Application Change Management Solution Patch Manager

The screenshot displays the Oracle Enterprise Manager 10g Patch Manager interface. The main window is titled 'Patch Oracle Applications: Patch Details' and contains several configuration fields:

- Target Stage Directory Location: (Directory where zipped patches are downloaded.)
- Target Patch Directory Location: (Directory location where patches are unzipped and applied from.)
- Download patches to the OMS:
- OMS Stage Directory Location: (Directory where zipped patches are downloaded on the OMS.)

Below these fields is the 'Oracle E-Business Suite Updates' section, which includes a table of available patches:

Patch ID	Product	Platform	Version	Description	Files
6874932	OAM	Linux x86	11i	11i INTEROPERABILITY PATCH FOR AMP 2.0.2	p6874932_11...

Buttons for 'Add Oracle Patch', 'Add Custom Patch', 'Check Prerequisites', and 'Remove All' are visible. A tip at the bottom states: 'TIP To look up for the README, selected updates should be valid patch on Oracle Metalink and require connection to OAM.'

An overlay window titled 'Missing Prerequisites' is open, showing a table of prerequisites for the selected patch:

Select Focus Prerequisites	Status
Targets	
a11bfaqa-Oracle Applications System	
6874932	✗
2614213	✓
3036401	✗
3219567	✓
3262486	✓
3262159	✓
3263588	✓
3263645	✓
3261254	✓
3261243	✓
3264818	✓
3264822	✓
3412795	✓
4337683	✓
4676589	✓
a11prdq-Oracle Applications System	
6874932	✓
2614213	✓
3036401	✓
3219567	✓
3262486	✓
3262159	✓
3263588	✓
3263645	✓
3261254	✓
3261243	✓
3264818	✓
3264822	✓
3412795	✓
4337683	✓
4676589	✓

The dialog box includes buttons for 'Add Oracle Prerequisites', 'Add Custom Prerequisites', and 'Cancel'. The status column indicates which prerequisites are missing (marked with a red 'X') and which are satisfied (marked with a green checkmark).

Pre-requisite patch checking

Application Change Management Solution

Patch Manager



Patch Oracle Applications: Schedule

Cancel Save Back Step 6 of 7 Next

Apply Patches Immediately
 Later

Time Zone (UTC-08:00) US Pacific Time (PST) ▼

* Date 04/27/2010

(MM/dd/yyyy)

Time 10 ▼ 00 ▼

Grace Period Indefinite

End After Hours Minutes

Blackout Length Hours Minutes

This is the amount of time the target system will have a blackout status in Enterprise Manager. Set this to a higher value for large patch runs.

Cancel Save Back Step 6 of 7 Next

- Schedule patch runs immediately or later
- Patch Manager is all about unattended patching
- Built-in status notifications

Application Change Management Solution

Setup Manager

Setup Manager Page Refreshed Apr 15, 2010 12:07:46 AM PDT

Projects

Search [Advanced Search](#)

|

Select	Name	Release	Owner	Last Updated On	Published	View Executions	Uploaded Extracts	Attachments
<input checked="" type="radio"/>	test	R12	SYSMAN	Mar 31, 2010 1:30:57 PM PDT				
<input type="radio"/>	KK_TEST	R12	SMUSER	Feb 1, 2010 6:35:45 AM PST				
<input type="radio"/>	TestPreviewExtract	R12	SYSMAN	Jan 15, 2010 4:42:50 AM PST				
<input type="radio"/>	KCC Ext	R12	SYSMAN	Jan 14, 2010 10:24:25 AM PST				
<input type="radio"/>	My First Prj	R12	SYSMAN	Dec 8, 2009 5:18:17 AM PST				
<input type="radio"/>	FinSetup	R12	SYSMAN	Dec 8, 2009 12:19:47 AM PST				
<input type="radio"/>	UploadedExtProject	R12	SYSMAN	Dec 8, 2009 12:14:17 AM PST				
<input type="radio"/>	utprj	R12	SYSMAN	Dec 8, 2009 12:03:13 AM PST				

TIP 'Create Like' would not copy Uploaded Extracts and Attachments associated with the Project.

Related Links

[Transform](#) [Interfaces](#)

- Project based Setup Migration
- Enforce dependencies/hierarchies
- Multi-source, multi-target migration

- Standard/Comparison reports
- Central console to access/manage operations

Manage functional setups across varies E-Business Suite using Setup Manager

Application Change Management Solution Setup Manager

Plan: Create Extract Task from Selection Set

Selection Set Templates are pre-defined selections of setup objects for an Extract. Choose a Selection Set Template as a starting point to create an Extract task. Templates are listed in the recommend

Select	Name	Description
<input checked="" type="radio"/>	General Foundation	This Selection Set is used to migrate AOL Foundation set ups.
<input type="radio"/>	Product Foundation	This Selection Set is used to migrate Foundation set up needed before migrating any other setup data for other products.
<input type="radio"/>	Organization Structure	This Selection Set is used to migrate the Organization Structure set up.
<input type="radio"/>	Financials Setup	This Selection Set is used to migrate Financials setup.
<input type="radio"/>	Financials Operating Unit Level Setup	This Selection Set is used to migrate operating unit level setups in Oracle Payables, Oracle Receivable and Cash Management modules.
<input type="radio"/>	Discrete Mfg. and Distribution	This Selection Set is used to migrate the Discrete Manufacturing and Distribution setups.
<input type="radio"/>	Lease Management Setups	This Selection Set is used to migrate Lease Management Setups.
<input type="radio"/>	Personalizations	This Selection Set is used to migrate Personalizations
<input type="radio"/>	Payroll Element	This Selection Set is used to migrate HRMS Payroll Elements.
<input type="radio"/>	XML Publisher	This Selection Set is used to migrate XML Publisher Metadata, Templates, Translations, XML Sample and Schema
<input type="radio"/>	Workflow Business Event System Objects	This Selection Set is used to migrate Workflow Business Event System Objects Definitions
<input type="radio"/>	Workflow Definitions	This Selection Set is used to migrate Workflow Definitions.
<input type="radio"/>	All Profile Options	This Selection Set is used to migrate all exportable profile options.
<input type="radio"/>	Australian Leave Liability	This Selection Set is used to migrate Australian leave liability setup.
<input type="radio"/>	General Ledger Daily Rates	This Selection Set is used to migrate General Ledger Daily Rates setup.
<input type="radio"/>	Employees	This Selection Set is used to migrate Employees data.
<input type="radio"/>	Projects Setup	This Selection Set is used to migrate Projects setup.
<input type="radio"/>	Suppliers	This Selection Set is used to migrate Suppliers setup.
<input type="radio"/>	Profitability Manager Setups	This Selection Set is used to migrate Profitability Manager setups.
<input type="radio"/>	Transfer Pricing Setups	This Selection Set is used to migrate Transfer Pricing Setups.

Over 300 Oracle owned solutions

Supports customer-created APIs

ORACLE

Application Change Management Solution

Setup Manager

ORACLE Enterprise Manager 10g Grid Control

Home Targets Deployments Alerts Compliance Jobs Reports

Oracle Applications | Hosts | Databases | Middleware | Web Applications | Services | Systems | Groups | All Targets

Setup Manager

Page Refreshed Dec 8, 2009 6:18:33 AM PST

Transforms

Search

Select Name	Release	Owner	Published	Last Updated On	Status	Freeze	Regenerate Template	Delete																																																																																				
HR_OU_1.xls [Compatibility Mode] - Microsoft Excel																																																																																												
<table border="1"> <thead> <tr> <th>A</th> <th>B</th> <th>C</th> <th>D</th> <th>E</th> <th>F</th> <th>G</th> <th>H</th> <th>I</th> <th>J</th> <th>K</th> <th>L</th> <th>M</th> <th>N</th> </tr> <tr> <th>Id</th> <th>ParentId</th> <th>Status</th> <th>Transformed</th> <th>Delete</th> <th>Name</th> <th>Group Name</th> <th>Location</th> <th>Date From</th> <th>Date To</th> <th>Internal External Flag</th> <th>Internal Address Line</th> <th>Type</th> <th>Attribute Cat</th> </tr> </thead> <tbody> <tr> <td>10000000</td> <td>1</td> <td>Updated</td> <td>Y</td> <td></td> <td>OU100-test1-1</td> <td>BG100 - Primary Business Grou</td> <td>HQ</td> <td>1951-01-01</td> <td></td> <td>INT</td> <td></td> <td>OU</td> <td></td> </tr> <tr> <td>10000001</td> <td>1</td> <td>Updated</td> <td>Y</td> <td></td> <td>JRTESTING_OU-test2-</td> <td>BG100 - Primary Business Grou</td> <td>HQ</td> <td>2009-02-09</td> <td></td> <td>INT</td> <td></td> <td>OU</td> <td></td> </tr> <tr> <td>10000002</td> <td>1</td> <td>Updated</td> <td>Y</td> <td></td> <td>OU100-1</td> <td>BG100 - Primary Business Grou</td> <td>HQ</td> <td>1951-01-01</td> <td></td> <td>INT</td> <td></td> <td>OU</td> <td></td> </tr> <tr> <td>10000003</td> <td>1</td> <td>Updated</td> <td>Y</td> <td></td> <td>JRTESTING_OU-New</td> <td>BG100 - Primary Business Grou</td> <td>HQ</td> <td>2009-02-09</td> <td></td> <td>INT</td> <td></td> <td>OU</td> <td></td> </tr> </tbody> </table>									A	B	C	D	E	F	G	H	I	J	K	L	M	N	Id	ParentId	Status	Transformed	Delete	Name	Group Name	Location	Date From	Date To	Internal External Flag	Internal Address Line	Type	Attribute Cat	10000000	1	Updated	Y		OU100-test1-1	BG100 - Primary Business Grou	HQ	1951-01-01		INT		OU		10000001	1	Updated	Y		JRTESTING_OU-test2-	BG100 - Primary Business Grou	HQ	2009-02-09		INT		OU		10000002	1	Updated	Y		OU100-1	BG100 - Primary Business Grou	HQ	1951-01-01		INT		OU		10000003	1	Updated	Y		JRTESTING_OU-New	BG100 - Primary Business Grou	HQ	2009-02-09		INT		OU	
A	B	C	D	E	F	G	H	I	J	K	L	M	N																																																																															
Id	ParentId	Status	Transformed	Delete	Name	Group Name	Location	Date From	Date To	Internal External Flag	Internal Address Line	Type	Attribute Cat																																																																															
10000000	1	Updated	Y		OU100-test1-1	BG100 - Primary Business Grou	HQ	1951-01-01		INT		OU																																																																																
10000001	1	Updated	Y		JRTESTING_OU-test2-	BG100 - Primary Business Grou	HQ	2009-02-09		INT		OU																																																																																
10000002	1	Updated	Y		OU100-1	BG100 - Primary Business Grou	HQ	1951-01-01		INT		OU																																																																																
10000003	1	Updated	Y		JRTESTING_OU-New	BG100 - Primary Business Grou	HQ	2009-02-09		INT		OU																																																																																

Offline transformation of EBS functional setups using MS Excel

Application Change Management Solution

Change Approval Framework

Change Approval

Page Refreshed Apr 14, 2010 6:30:34 PM PDT

Requests

Name

Module

Requests ID

Status

Requests ID	Name	Module	Status	Requested By	Last Updated Date	Update
102632	ChangeTester:	Setup Manager	Approved	SYSMAN	Dec 23, 2009 2:36:48 PM PST	
102633	ChangeTester:	Setup Manager	Approved	SYSMAN	Dec 23, 2009 2:36:48 PM PST	
577	ChangeTester:Register custom application XXLOK on OCM12AA	Customization Manager	Approved	CMUSER	Dec 18, 2009 8:53:50 AM PST	
576	ChangeTester:Register custom application XXLOK on OCM12AA	Customization Manager	Approved	CMUSER	Dec 18, 2009 8:53:49 AM PST	
575	ChangeTester:Register custom application XXLOK on OCM12AA	Customization Manager	Approved	CMUSER	Dec 18, 2009 8:53:48 AM PST	
574	ChangeTester:Register custom application XXLOK on OCM12AA	Customization Manager	Approved	CMUSER	Dec 18, 2009 8:53:47 AM PST	
573	ChangeTester:Register custom application XXLOK on OCM12AA	Customization Manager	Approved	CMUSER	Dec 18, 2009 8:53:45 AM PST	
572	ChangeTester:Register custom application XXLOK on OCM12AA	Customization Manager	Approved	CMUSER	Dec 18, 2009 8:53:44 AM PST	
571	ChangeTester:Register custom application XXLOK on OCM12AA	Customization Manager	Approved	CMUSER	Dec 18, 2009 8:53:43 AM PST	
570	ChangeTester:Register custom application XXLOK on OCM12AA	Customization Manager	Approved	CMUSER	Dec 18, 2009 8:53:42 AM PST	
569	ChangeTester:Register custom application XXLOK on OCM12AA	Customization Manager	Approved	CMUSER	Dec 18, 2009 8:53:41 AM PST	
568	ChangeTester:Register custom application XXLOK on OCM12AA	Customization Manager	Approved	CMUSER	Dec 18, 2009 8:53:40 AM PST	

Complete history of all Pending Approval, Approved and Rejected changes for Patch Manager, Customization Manager, and Setup Manager

Application Change Management Solution

Change Approval Framework

View Request: [ChangeTester:Register custom application XXLOK on OCM12AA](#)

[View Details](#) [Update](#)

Module **Customization Manager**
 Requester Name **CMUSER**
 Justification **Customizations need to be promoted to prod**

▼ Targets

Target Name
utenvr2-Oracle E-Business Suite
1
2

▼ Notification E-mail(s)

E-mail Address
No Emails Added

▼ Related History

⊖ Previous 1-15 of 200 ⊕

Name	Action	Comments	Owner	Created Date
ChangeTester:	Rejected by user	Kommentaire: Patch was created with Customization Manager and has been verified in the test instance	SYSMAN	Dec 23, 2009 2:37:46 PM PST
ChangeTester:	Rejected by user	Kommentaire: Patch was created with Customization Manager and has been verified in the	SYSMAN	Dec 23, 2009 2:37:45 PM PST

Detailed history of all changes

Application Change Management Solution

Change Management Dashboard

Oracle Applications

System Management

Change Management

Page Refreshed Apr 14, 2010 5:21:35 PM (UTC-05:00)

Change Approval Requests

Recent Activity

Requests ID	Name	Module	Status	Requested By
113	Execute 31 Test ebs2 Only: Ex4	Setup Manager	Approved	SYSMAN
110	Execute 31 Test ebs2 Only: Ex3	Setup Manager	Approved	SYSMAN
107	Execute 31 Test ebs2 Only: Ex2	Setup Manager	Approved	SYSMAN
104	Execute 31 Test ebs2 Only: Ex1	Setup Manager	Approved	SYSMAN
101	Execute 31 Printer: Ex. 1	Setup Manager	Approved	SYSMAN

Search Change Approval Requests

Name

Requests ID

Module

Status

Related Links

[Home](#)

Patch Manager

Completed: 17 ✓ (51%) 16 ✗ (48%) In Progress: 0 Scheduled: 0

Recent Activity

Start a Patch

Name	Status	Last Updated Date
31 Patch 6 - EBS and Custom on ebs2	Succeeded	01:41:35 PM Apr 07 2010 GMT-05:00
31 Patch EBS Only	Succeeded	01:13:18 PM Apr 07 2010 GMT-05:00

Search Patches Applied

Oracle E-Business Suite

Patch Number

Related Links

[Home](#)

- Track most recent changes at-a-glance
- Complete view into all changes across your Oracle E-Business Suite instances
- Enforce segregation of duties between DBA, developers, and functional experts

Application Change Management Solution

Change Management Dashboard

Customization Manager

Packages Released: 0 (Release 11i) 0 (Release 12)

Recent Activity

Package Name	Owner	Status	Last Updated Date
Demo 112	SYSMAN	Succeeded	2010-04-07
31 Test 2	SYSMAN	Succeeded	2010-04-07
31 Test	SYSMAN	Succeeded	2010-04-01
Angelo 45	SYSMAN	Succeeded	2010-03-10
TEST KEB1	SYSMAN	Succeeded	2010-03-05

Search Packages

Name

Related Links

[Home](#) [Create Package](#)
[File Source Mapping](#) [E-Business Suite Mapping](#)
[Package Report](#) [File Metadata Repository](#)
[Custom Applications](#) [Custom Application Requests](#)

Setup Manager

Projects Summary: 0 (Release 11i) 15 (Release 12)

Recent Activity

Project Name	Last Updated Date
31 Test ebs2 Only	04:08:11 PM Apr 13 2010 GMT-05:00
31 Printer	02:53:40 PM Mar 22 2010 GMT-05:00
Rogers Printers	02:28:23 PM Mar 22 2010 GMT-05:00
Test KEB1	12:23:05 PM Mar 05 2010 GMT-05:00
lberdola	07:04:20 PM Feb 25 2010 GMT-05:00

Search Projects

Project Name

Related Links

[Home](#) [Create Project](#)
[Transform](#) [Interfaces](#)

Application Change Management solution provides
automation, auditing, change, alerts, notifications, and more

Application Change Management Solution

Reduce Total Cost of Ownership

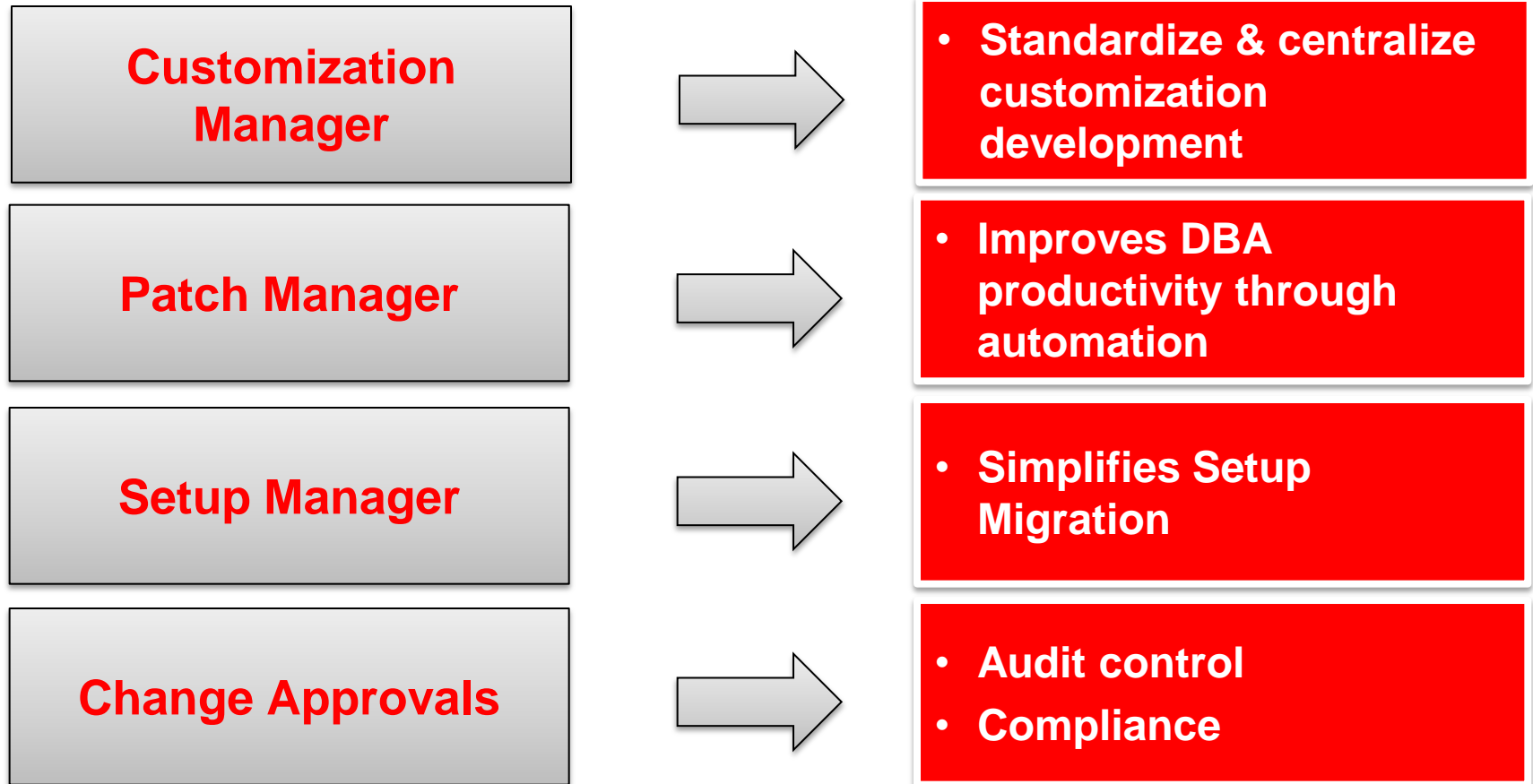



**Application Management
Suite for E-Business Suite**

**SOFTWARE.
HARDWARE.
COMPLETE.**

ORACLE

Application Management Suite for Oracle E-Business Suite



Component Monitoring

Configuration Reporting

Service Level Management

Automated Cloning & Patching

Transaction Diagnostics

Concurrent Processing Dashboard

User Monitoring

Change Management for EBS



Roadmap

SOFTWARE.
HARDWARE.
COMPLETE.

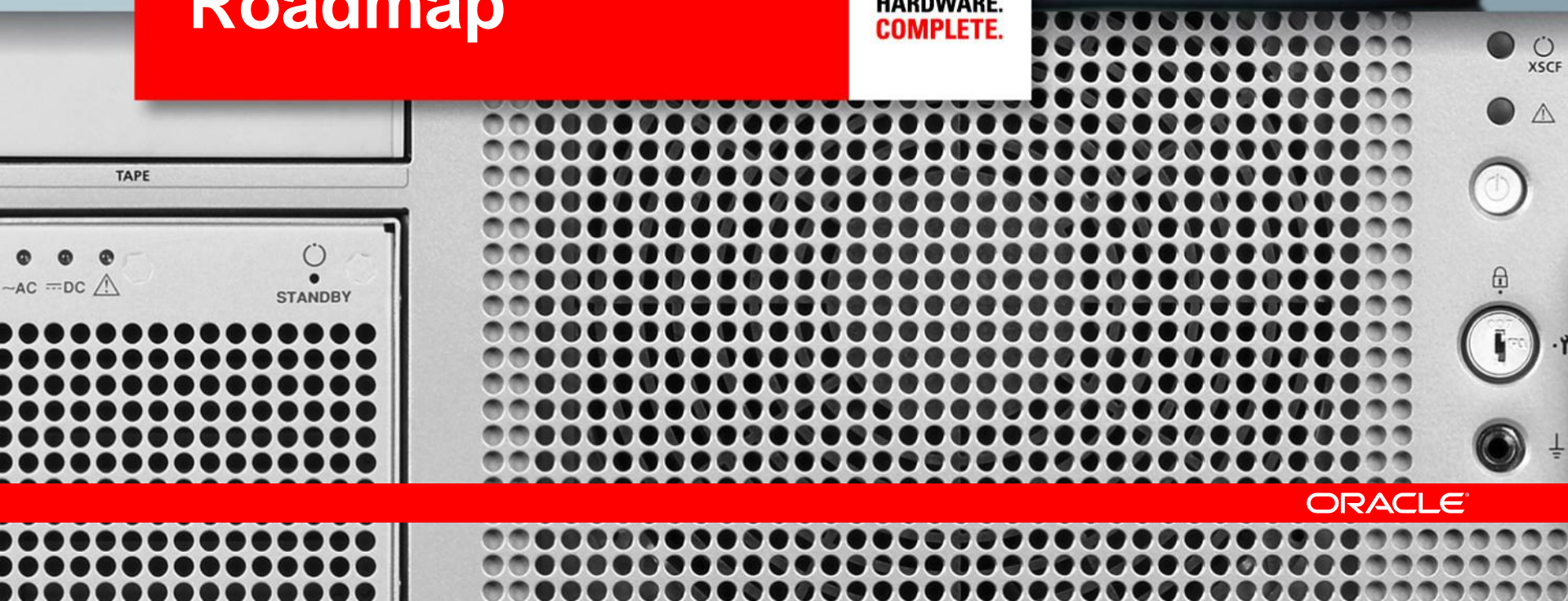

Roadmap

- Certification
 - Enterprise Manager Grid Control 11gR1
- Customization Manager
 - Support additional customization file types
 - Extensible Standards Validation
- Patch Manager
 - Patch Promotion
 - Patch Advisory & Recommendations
- Setup Manager
 - Impact Analysis
- Change Approval
 - Integration with third party Change Approval tools
- Security
 - Sudo/Powerbroker Support



JHUAPL Case Study

SOFTWARE.
HARDWARE.
COMPLETE.

ORACLE



APL

The Johns Hopkins University
APPLIED PHYSICS LABORATORY

ORACLE®

Application Change Management in the Grid

The Johns Hopkins University Applied Physics Laboratory

Raymond R. Payne, Principal Systems Architect

Agenda

- **Who we are**
- **Business Challenges**
- **Why Grid Computing Architecture**
- **Business & Software Requirements**
- **Project Implementation & Notes**
- **Project Results**
- **Productivity Gains**

Introduction to the Applied Physics Laboratory

Our Work



As a not-for-profit division of the Johns Hopkins University, APL serves as a technology resource to the Department of Defense and other Government agencies. Our work spans more than 400 programs, conducted for a wide variety of military and civilian sponsors, organized within 11 business areas.

Each business area comprises a set of programs grouped as a unit with common application of resources and management. Many business areas are based on capabilities and expertise supporting long-term programs, such as Air & Missile Defense or Strategic Systems. Some are relatively new or represent a more defined focus, such as National Security Space and Homeland Protection.

Our Customers



Key aspects of the APL Grid Control Installation

- Version of ACMP: 3.1
- Version of E-Business Suite: 12.1.2
- Database size: 200Gb
- E-Business Suite Environments: 30+
- Version of Enterprise Manager: 10.2.0.5.3
- Number of Targets: 1,000+
- Platforms: Sunfire 6800, HP Proliant DL365, HP Proliant DL580, EMC Clarion, BigIP F5,

Key aspects of the APL' are

- Number of System Administrators and DB/Apps Administrators: 3/5
- Other Enterprise Manager Packs and plug-ins being used:
 - Provisioning Pack for Database, Configuration Management Pack for Database, Diagnostic & Tuning Pack
 - EMC Storage Plug-in
 - F5 Plug-in
 - Linux Management Pack
- Other Applications:
 - PeopleSoft HCM and Payroll
 - Oracle Business Intelligence

Business Challenges

Legacy Methods

- Many different individuals involved at various stages
- Relied on manual entry and re-entry of setup data
- No checks and balances in place (approve early, approve often!)
- Where automation existed, it was home grown and had many different authors ... some of which were not retired!
- Methods were tedious to maintain and did not always follow best practices
- Audit trail sketchy at best

Use Case

Legacy E-Business Suite Change Management

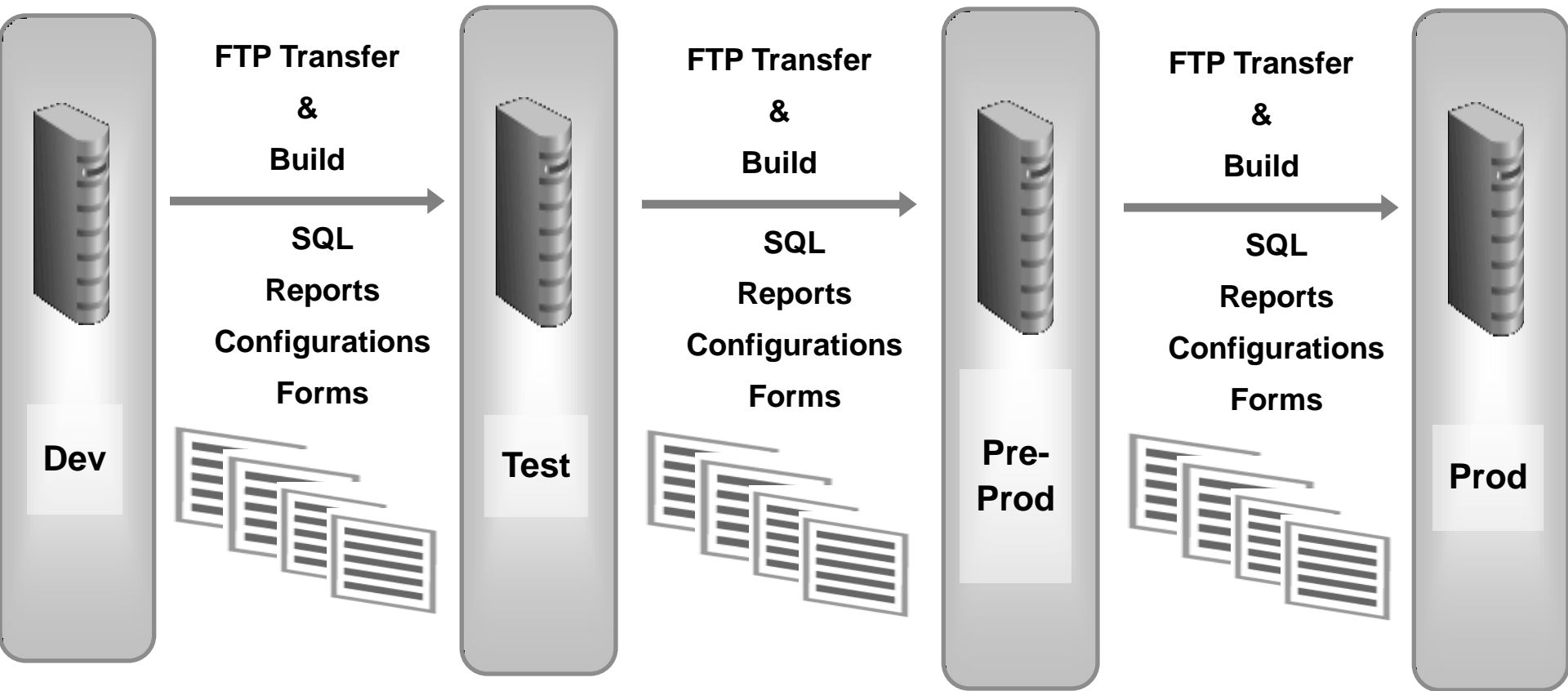

Challenges: • **Manual** • **Complex** • **Repetitive** • **No Reporting**

Why Grid Computing Architecture

Rationale

- E-Business Suite deployed in the GRID
- Maximum scalability and agility
- Ability to orchestrate “many as one” with Enterprise Manager Grid Control
- Increased demand for uniformity, compliance, and consistency across the servers comprising the grid

Business Requirements

- New implementation project to require more than 20 non-production environments
- Large development team with multiple leads and multiple domains of control
- Production architecture to consist of multiple synchronized “APPL_TOPs”
- Multiple stages of development life cycle with multiple configuration managers involved ... requirement for strict segregation and control
- Requirement for audit report and support

Software Requirements

Evaluation of Tools

- Documentation of Use Case Scenarios
- Suitability for Grid Environment
- Use of embedded Oracle extensions and services
- Extensibility
- Compatibility with other Oracle products
- Integration with Source Code Management Systems

Project Implementation

Application Change Management Pack for EBS

- Six week accelerated adoption program
- Validation of all identified use cases
- Integration and testing with development IDE tools
- Integration and testing with Source Code Management System
- Development of operational manuals and training materials
- Conducting development staff training sessions
- 3 months with 1.5 FTEs (E-Business Suite DBAs)

Application Change Management Pack for EBS

Deployment (notional)

- 1) Developers use IDE to check in/out of GFORGE
- 2) Developers use OEMGC to interact with ACP to migrate changes to development environment(s)
- 3) Test configuration manager uses ACP to migrate changes to test environment(s)
- 4) UAT configuration manager uses ACP to migrate changes to UAT environment(s)
- 5) ISS Data Management staff use ACP to migrate changes to PROD environment as instructed via CMS Ticket

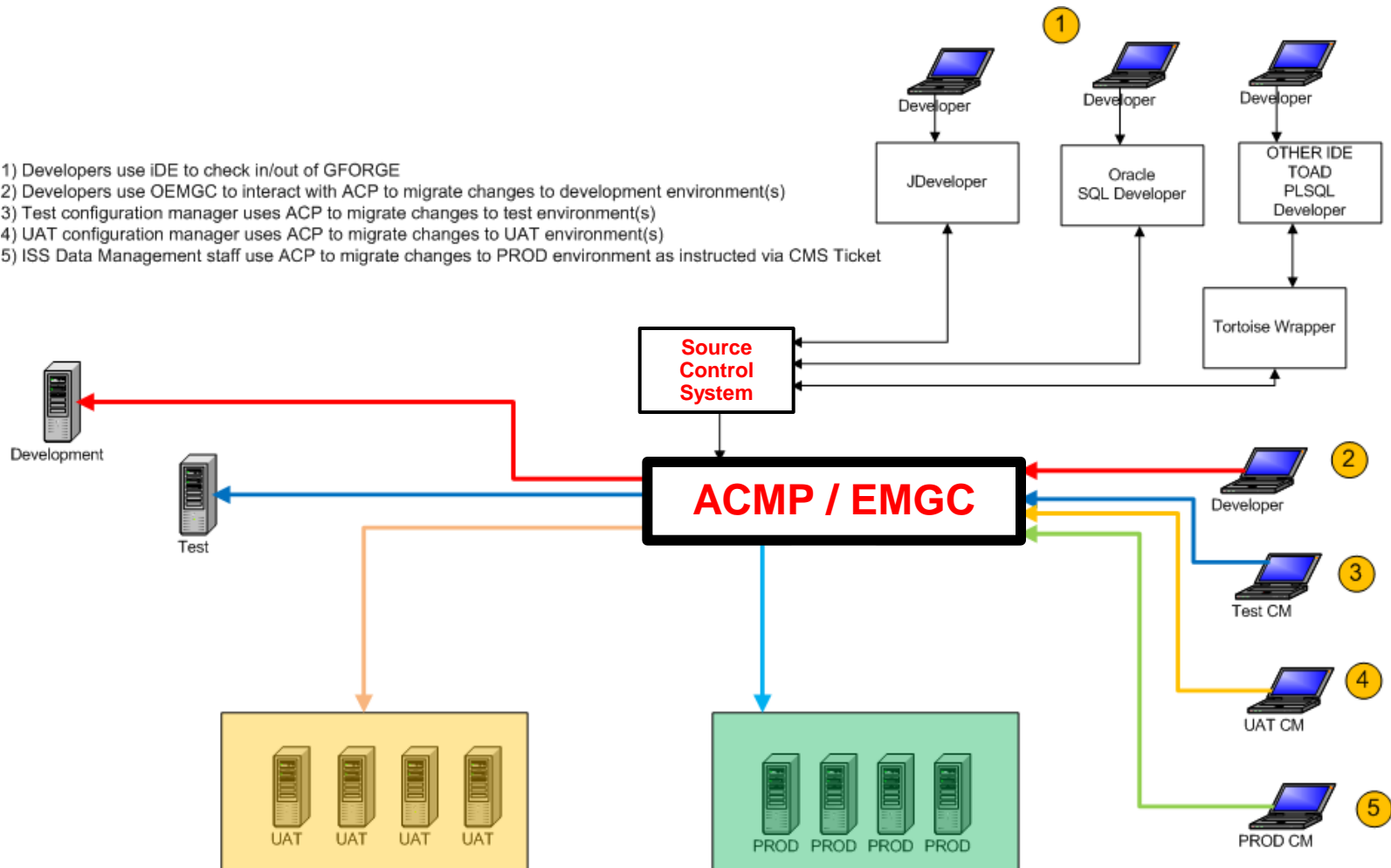

Implementation Notes

- ALL custom artifacts promoted through environments to production via ACMP
- ALL setup information promoted through environments to production via ACMP
- ALL patches promoted through environments to production via ACMP
- Change Approval Framework and granular Role Based authorization provide segregation of duties

Project Results

- Development teams now building extensions and setups bundled for release
- Integration with Source Code Control and Approval Framework, together with extensive documentation capabilities result in improved audit visibility
- Downstream setup and configuration errors virtually eliminated
- Integration with Grid Control provides agility and flexibility for scheduling and execution of change packages
- Need for deployment “specialists” almost eliminated

Productivity Gains

Reduction in Total Cost of Ownership

- Reduced operator (i.e., DBA) time to promote E-Business Suite patches by approximately 85% . Patches that used to take hours for prep and execution now can be accomplished in a matter of minutes
- Reduced administrator time to promote E-Business Suite Customizations by approximately 90% from 20 hours a week to 2 hours or less.
- Reduced operator (i.e., Business Analyst) time to promote E-Business Suite Functional Setups by approximately 80%, from 30 hours per week to 5 hours or less



Related Sessions

**SOFTWARE.
HARDWARE.
COMPLETE.**

ORACLE

Related Sessions

Monday (20th September)

- [S317039: Oracle@Oracle: How Oracle IT Achieves High Application Service Levels](#)
Time: 11.00 – 12.00
Venue: Moscone West L2 (RM 2020)
- [S317132: Oracle E-Business Suite Technology: Vision, Release Overview, Product Roadmap](#)
Time: 12.30 – 13.30
Venue: Moscone West L2 (RM 2002/2004)

Tuesday (21st September)

- [S318132: Quick Wins That Will Make You a Hero: Oracle E-Business Suite Technology](#)
Time: 12.30 – 13.30
Venue: Moscone West L2 (RM 2024)
- [S318134: Oracle E-Business Suite DBA Techniques: Minimizing Maintenance Downtimes](#)
Time: 14.00 – 15.00
Venue: Moscone West L2 (RM 2024)

Related Sessions

Tuesday (21st September)

- [S318124: Latest on Oracle Application Change Management Pack for Oracle E-Business Suite – Customer Case Study \(JHUAPL\)](#)

Time: 15.30 – 16.30

Venue: Moscone West L2 (RM 2024)

Wednesday (22nd September)

- [S318119: Oracle E-Business Suite Technology Certification Primer and Roadmap](#)

Time: 10.00 – 11.00

Venue: Moscone West L2 (RM 2024)

- [S318125: Upgrading Your Customizations to Oracle E-Business Suite Release 12](#)

Time: 11.30 – 12.30

Venue: Moscone West L2 (RM 2024)

- [S318122: Oracle E-Business Suite Technology: Vision, Release Overview, Product Roadmap](#)

Time: 16.45 – 17.45

Venue: Moscone West L3 (RM 3002 / 3004)

Related Sessions.....contd.

Thursday (23rd September)

- **S318123: Reduce TCO with Oracle Application Management Pack for Oracle E-Business Suite – Customer Case Study (FHR)**
Time: 9.00 – 10.00
Venue: Moscone West L2 (RM 2024)
- **S318120: Oracle E-Business Suite Architectures: Oracle RAC, Clouds, Oracle VM, and More**
Time: 12.00 – 13.00
Venue: Moscone West L2 (RM 2024)
- **S318133: Oracle E-Business Suite DBA Techniques: Install and Cloning Best Practices**
Time: 13.30 – 14.30
Venue: Moscone West L2 (RM 2024)

Related Hands on Labs

Application Management Pack

- [S318765: Oracle Application Management Pack for Oracle E-Business Suite: Monitor/Clone](#)
Date: Monday (20th September)
Time: 17.00 – 18.00
Venue: Marriott Marquis Nob Hill C&D

Application Change Management Pack

- [S318766: Using Oracle Application Change Management Pack for Oracle E-Business Suite](#)
 - Date: Tuesday (21st September)
Time: 11.00 – 12.00
 - **Repeat** Date: Wednesday (22nd September)
Time: 16.45 – 17.45
 - Venue: Marriott Marquis Nob Hill C&D

Oracle E-Business Suite Technology Demopods

Moscone South

S - 089

Upgrading to Oracle E-Business Suite 12.1

S - 090

Advanced Architectures and Technology Stack Components

S - 091

SOA-Based Integration for Oracle E-Business Suite

S - 092

End-to-End Management of Oracle E-Business Suite

S - 093

Oracle Applications Framework Rich UI and Enhanced Web ADI

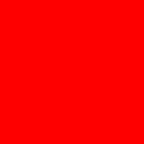

The preceding is intended to outline our general product direction. It is intended for information purposes only, and may not be incorporated into any contract. It is not a commitment to deliver any material, code, or functionality, and should not be relied upon in making purchasing decisions. The development, release, and timing of any features or functionality described for Oracle's products remains at the sole discretion of Oracle.



QUESTIONS
ANSWERS

SOFTWARE. HARDWARE. COMPLETE.

We encourage you to use the newly minted corporate tagline “Software. Hardware. Complete.” at the end of all your presentations. This message should replace any reference to our previous corporate tagline “Oracle Is the Information Company.”

Appendix



Application Change Management Solution

Summary of key features

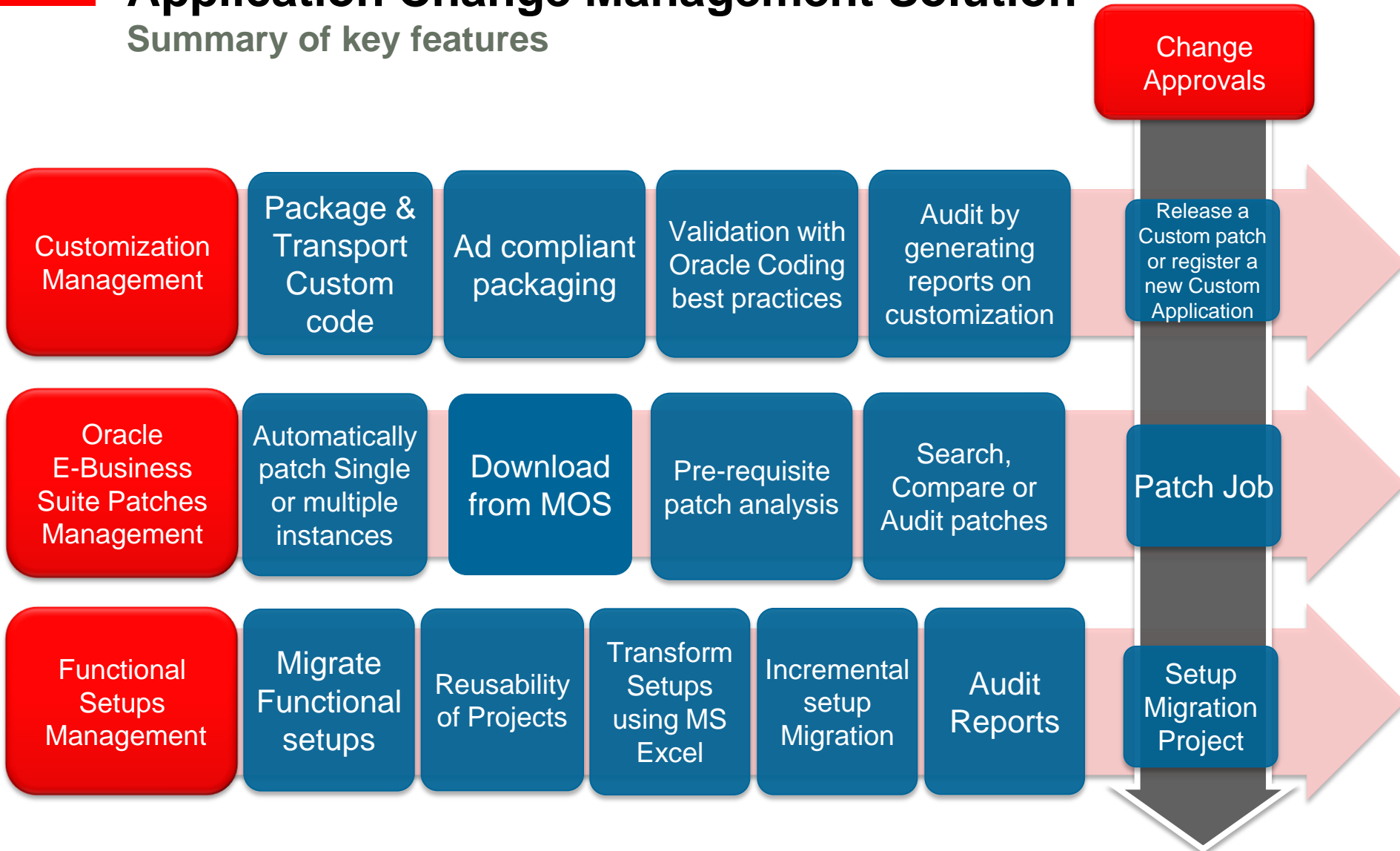

Additional Information

- The Application Management Pack and Application Change Management Pack is available as a single install using Oracle Universal Installer
- Release 3.1 is an upgrade from Release 3.0
- Certification
 - OS: Linux, Solaris, HP-UX, IBM AIX
 - Enterprise Manager Grid Control:10gR5
 - Oracle E-Business Suite Release:
 - 11.5.10 CU2 + 11i.ATG_PF.H.RUP6
 - Release 12.0.4 + R12.ATG_PF.A.delta.6
 - Release 12.1
- My Oracle Support
 - Patch Details: 8333939
 - Product documentation: Note 982302.1

Product Management Contacts

- ✓ Angelo.Rosado@oracle.com
- ✓ Kenneth.Baxter@oracle.com

Additional Resources

- For more release information on MetaLink
 - https://metalink.oracle.com/metalink/plsql/ml2_documents.showDocument?p_database_id=NOT&p_id=403259.1
- For more information about Oracle Applications
 - <http://www.oracle.com/applications/home.html>
- For more information about Education
 - <http://www.oracle.com/education/index.html>
- For more information about Support
 - <http://www.oracle.com/support/>
- For MetaLink information
 - <http://metalink.oracle.com/>
- For Oracle Product documentation:
 - <http://www.oracle.com/technology/documentation/applications.html>

Oracle Products Available Online



Oracle Store

SHOP NOW

Buy Oracle license and support
online today at
[oracle.com/store](https://www.oracle.com/store)

ORACLE®