

**ORACLE®**

## Leveraging Oracle Fusion Middleware in Agile PLM

Gnani Palanikumar  
Product Management Director

# Safe Harbor Statement

The following is intended to outline our general product direction. It is intended for information purposes only, and may not be incorporated into any contract. It is not a commitment to deliver any material, code, or functionality, and should not be relied upon in making purchasing decisions.

The development, release, and timing of any features or functionality described for Oracle's products remains at the sole discretion of Oracle.

# Agenda

- Fusion Middleware Overview
- Fusion Middleware Integration
- Solutions
- Benefits

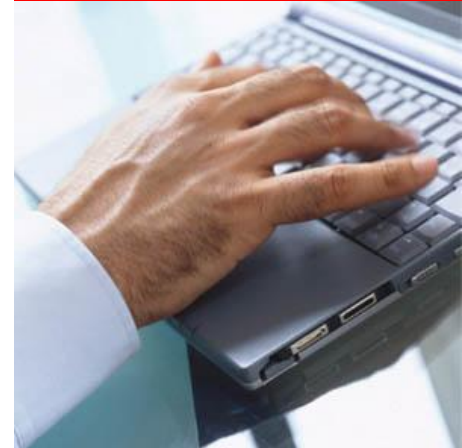

# Agile PLM

## Oracle Fusion Middleware Best Practice Center

**ORACLE**

AGILE

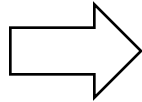

Agile is a leading provider of PLM applications that enable companies to accelerate product innovation and maximize product profitability by managing the product information throughout their lifecycles

**ORACLE**  
FUSION MIDDLEWARE

**11<sup>g</sup>**

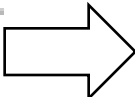

Next generation Oracle Middleware built using best-of-breed standard based middleware technology, which is in use by 90,000 customers worldwide

Our focus here is what customers and partners can build today using Fusion Middleware to extend Agile PLM Applications A9 and e6

# Oracle Fusion Middleware

## Overview



### Development Tools

Unified SOA Development Tool & Framework



### User Interaction

Web 2.0 Portal, Rich Internet Apps, Mobile, Search, Desktop, Presence, VoIP



### Business Intelligence

Data Integration, Query & Analysis, OLAP, Dashboards, Reports, Alerts, Real-Time



### Content Management

Web Content, Documents, Digital Assets, Imaging, Records, Information Rights



### SOA & Process Management

ESB, BPEL PM, Workflow, BAM, Rules, B2B, MDM, Registry, SOA Governance



### Application Server

Java EE, Web Services, Complex Event Processing, XTP, RFID & Sensors, SIP



### Grid Infrastructure

Application Clusters, In-Memory Data Grid, Common Metadata Services



### Enterprise Management

Provisioning, Diagnostics, Tuning, Configuration Management



### Identity Management

Provisioning, Access Management, Federation, Audit, Directory

# Oracle Fusion Middleware

## Agile Certified Components

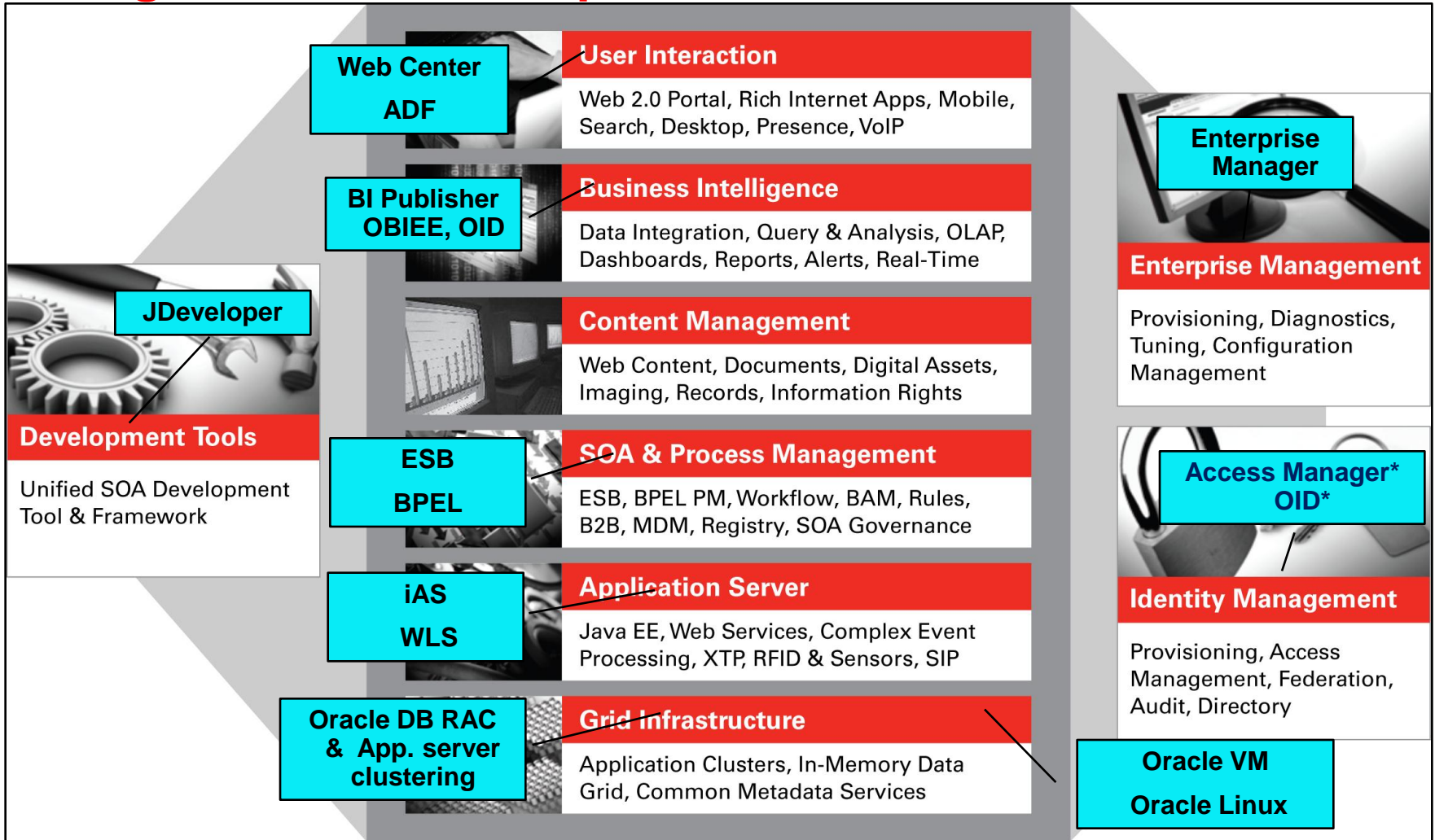

# Agile PLM

## Solutions Leveraging Fusion Middleware



# Leveraging OFM: Where do we start?

## Identify Requirements, Learn Fusion Middleware Component

| Requirements                              | Fusion Middleware Components   |
|---|--|
| Integrating with various applications     | <ul style="list-style-type: none"><li>• Oracle Application Integration Architecture (AIA)</li><li>• SOA &amp; Process Management: BPEL Process Manager, Oracle Service Bus</li></ul> |
| Authoring Tool Integration                | <ul style="list-style-type: none"><li>• SOA &amp; Web Services</li></ul>   |
| Portal UI, Mobile Applications            | <ul style="list-style-type: none"><li>• Oracle Web Center, ADF. Mobile ADF</li></ul>   |
| Enterprise Reporting                      | <ul style="list-style-type: none"><li>• BI Publisher</li></ul>   |
| Business Intelligence                     | <ul style="list-style-type: none"><li>• OBIEE, ODI</li></ul>   |
| Enterprise Identity and Access Management | <ul style="list-style-type: none"><li>• Identity Management” Oracle Internet Directory,* Oracle Access Manager*</li></ul>  |
| Lower Total Cost of Ownership             | <ul style="list-style-type: none"><li>• Application Management (Enterprise Management), Application Server (WebLogic, iAS), DB &amp; App clusters, Oracle Linux, Oracle VM</li></ul> |
| Application Customization                 | <ul style="list-style-type: none"><li>• J2EE Development Environment: JDeveloper, ADF, ADF Mobile</li></ul>  |

# Enterprise Integration and Process Management Using AIA Process Integration Pack (PIP)

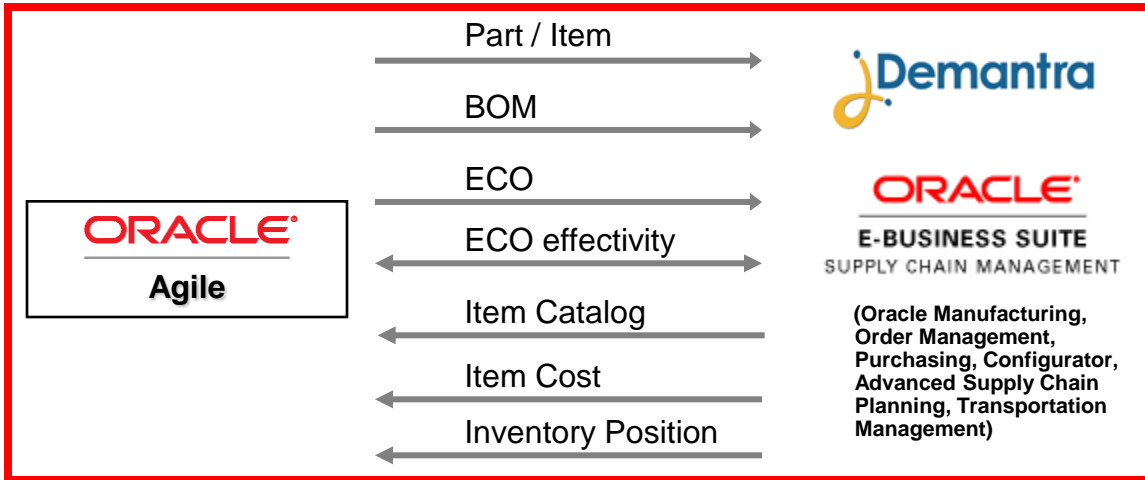

## Challenges

- Non-integrated release process yield data inaccuracy and added time to market
- Limited support for Design for Cost and supply chain results in higher costs

## Solutions

- AIA: Agile Design to Release PIP to Oracle E-Business Suite
- Fusion Middleware: Oracle BPEL Process Manager
- Applications: Agile, Demantra, E-Business Suite
- PIP enables seamless, real-time data access to 360 Degree View, Item Management, Change Management, and Configurator.

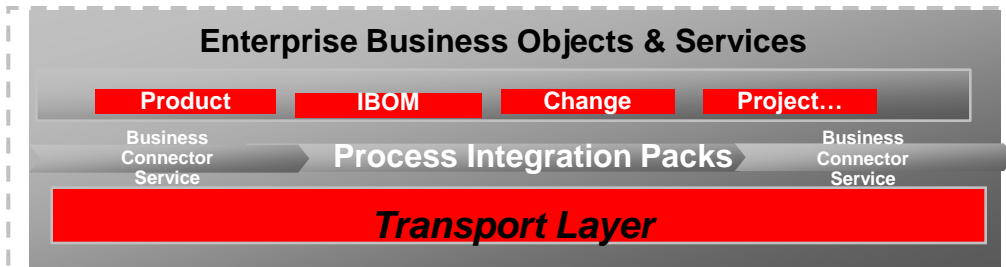

**Oracle AIA**

**Oracle Fusion Middleware**

# Activity Based Workflow in Agile PLM

## Using BPEL and Agile Web Services

### New Part Creation Process with integrated BPEL Workflow

| Task                          | Action          | State     | Updated By | Updated Date          |
|-------------------------------|-----------------|-----------|------------|-----------------------|
| Costing                       | Open Activity   | Pending   | jstein     | Apr 24, 2009 11:41 AM |
| Set OM Attributes and Pricing | Attributes Set  | Assigned  | miralele   | Apr 24, 2009 11:40 AM |
| Set Buyer/Planner Attributes  | Attributes Set  | Completed | cdickers   | Apr 24, 2009 10:55 AM |
| Create Routing                | Routing Created | Completed | cdickers   | Apr 24, 2009 10:40 AM |
| Classify Item                 | Item Classified | Completed | tsiemert   | Apr 23, 2009 4:26 PM  |

### Challenge

- Creation of cross-application (PLM, ERP) process flows

### Solution

- Fusion Middleware: BPEL Process Manager
- Applications: Agile, E-Business Suite
- E-Business activities can be orchestrated as BPEL services
- Agile workflow state change event and Web Services provides a mechanism to launch E-Business suite BPEL workflow
- Agile ECO cover page attribute can be used to track E-Business Suite workflow process status

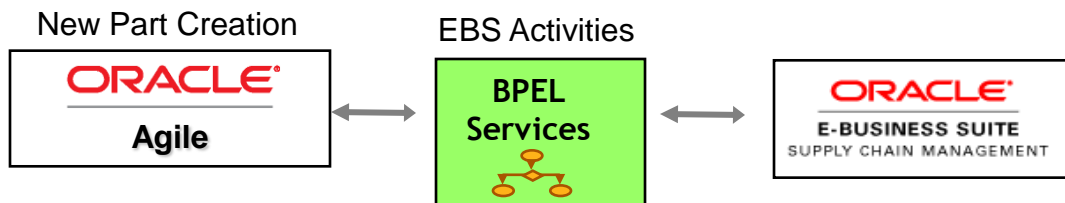

Oracle BPEL Process Manager

Oracle Fusion Middleware

### Benefits

- 360 view of product data (Agile, EBS) within Agile

# CAD Integration in Agile PLM

## Using BPEL and Agile EC Web Services

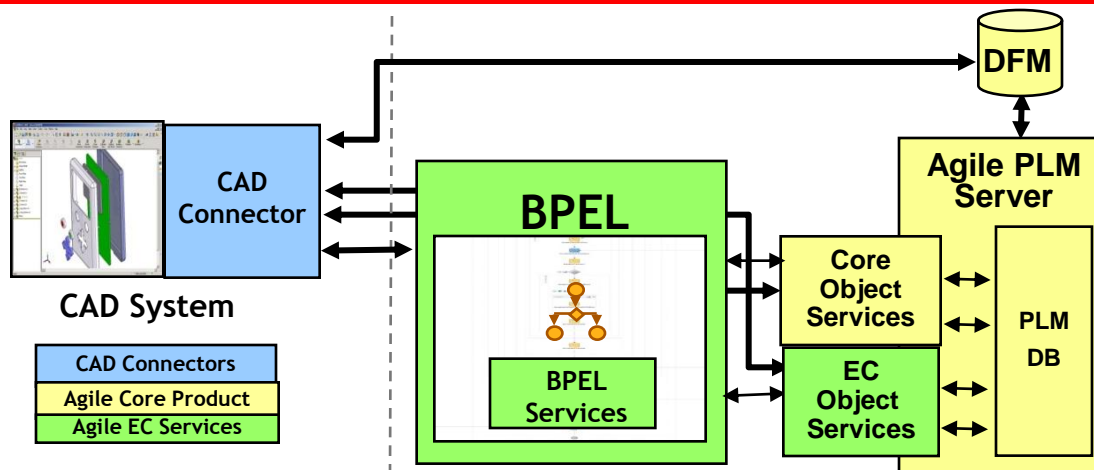
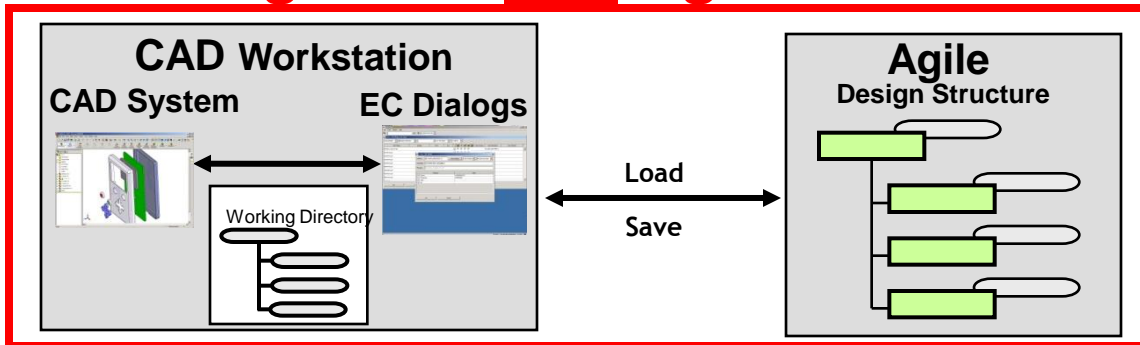

### Challenges

- WAN performance of CAD connectors
- Ability to customize business logic based on business requirements

### Solutions

- Fusion Middleware: BPEL Process Manager
- Applications: Agile, CAD Tools
- Agile EC services migrates some CAD connector logic to server side using BPEL services
- BPEL editor provides ability to customize Agile EC BPEL orchestrated flows
- BPEL Process Manager provides infrastructure for deploying and managing BPEL business processes

**Oracle BPEL Process Manager**

**Oracle Fusion Middleware**

### Benefits

- Improves efficiency of partners and customers to develop & maintain CAD connectors

# Custom Web Applications in Agile PLM

## Using ADF and Agile Web Services

**ORACLE**

classIdentifier: Part  
 \*objectNumber: P00216  
 id: 375  
 resolution: DISABLE  
 tableIdentifier: 801  
 timestamp: 8/20/2009

statusCode: SUCCESS  
 objectId: 6164358

getObject

Item Management

Site Directory

| Item Type | Item Description                                      | Life Cycle Phase |
|-----------|---|------------------|
| Part      | 100001 Gomme all year money, AAAA88888 ye land-lover! | Preliminary      |
| Part      | 100002  | Preliminary      |
| Part      | 100003  | Preliminary      |
| Part      | 100007  | Preliminary      |
| Part      | 100008  | Preliminary      |

| Attachment | File Name | File Description | File Type | Item Number | Folder Description | Folder Version |
|------------|-----------|------------------|-----------|-------------|--------------------|----------------|
| 100001     | 100001    | 100001           | FOLDER    | 100001      | 100001             | 1              |
| 100002     | 100002    | 100002           | FOLDER    | 100002      | 100002             | 1              |
| 100003     | 100003    | 100003           | FOLDER    | 100003      | 100003             | 1              |
| 100007     | 100007    | 100007           | FOLDER    | 100007      | 100007             | 1              |
| 100008     | 100008    | 100008           | FOLDER    | 100008      | 100008             | 1              |

Document Management

### Challenge

- Simplified UI for Casual users: Document Management, Item Management. Price & Compliance data import

### Solution

- Fusion Middleware: Application Design Framework (ADF), JDeveloper
- Application: Agile
- Oracle ADF provides visual and declarative approach to Java EE Web applications development
- ADF Business Services layer manages interactions with data persistent layer leveraging Agile Web Services

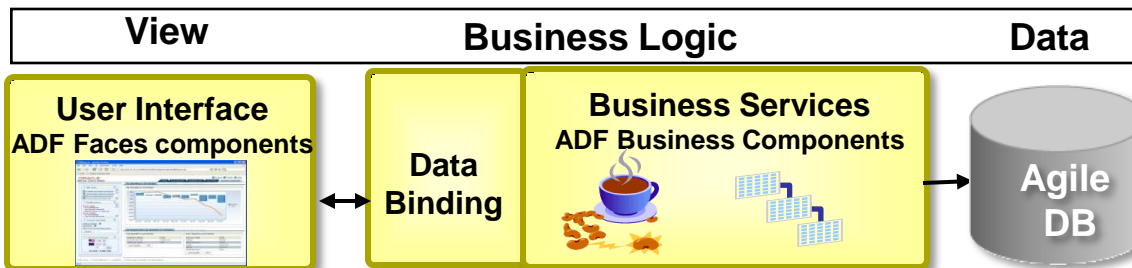

### Benefits

- Increase casual user adoption
- Less training overhead

**Oracle ADF**

**Oracle Fusion Middleware**

# Mobile Applications in Agile PLM

## Using ADF Mobile and Agile Web Services



RFQ Search

RFQ Details

RFQ Approval

### Challenge

- Access to PLM use cases (ECO Approval, Sales RFQ) from mobile devices:

### Solutions

- Fusion Middleware: Mobile ADF, JDeveloper
- Application: Agile

### HTML Support

- Basic mobile web applications
- Consumer mobile phones with simple HTML browse

### AJAX Support

- Rich mobile web applications
- High-end consumer phones with AJAX-enabled browser

### Java Client

- Applications integration with device PIM apps and peripherals
- High-end Smart Devices

- Mobile ADF provides a framework to create Mobile applications for HTML, Ajax and Java enabled Mobile devices
- Agile data can be presented in a Mobile applications using Agile Web Services

**Oracle Mobile ADF**

**Oracle Fusion Middleware**

### Benefits

- Improves mobile users productivity

# Composite Application Integration

## Using Web Center and Agile Web Services

Product Defect Escalation Dashboard  
Customer Needs Management

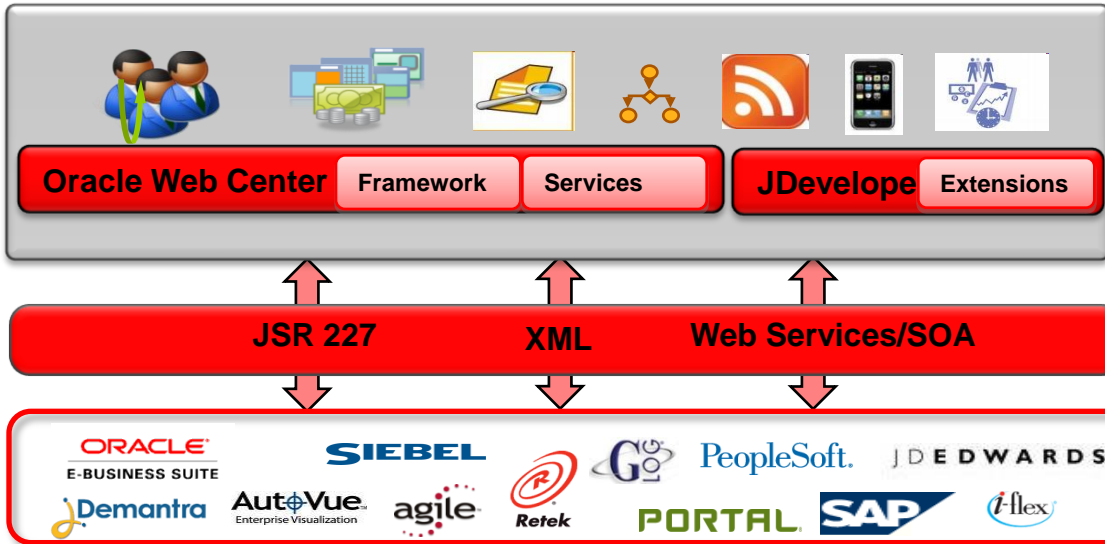

Oracle Web Center

Oracle Fusion Middleware

### Challenge

- Composite and Mashups applications: Product Defect Escalation, Customer Needs Management Dashboard

### Solutions

- Fusion Middleware: Oracle Web Center, ADF, JDeveloper
- Applications: Agile, E-Business Suite, Siebel and BI
- Oracle Web Center is an enterprise portal designed for business users and IT
- Unified with Business applications , Enterprise 2.0 services and social communities

### Benefits

- Easy to develop and maintain composite and Mashup applications

# Custom Reports & Datasheets in Agile PLM

## Using BI Publisher and Agile Java API & Web Services



Operational Reports



Product Datasheets & Manual

### Extract

### Transform

### Publish

### Distribute

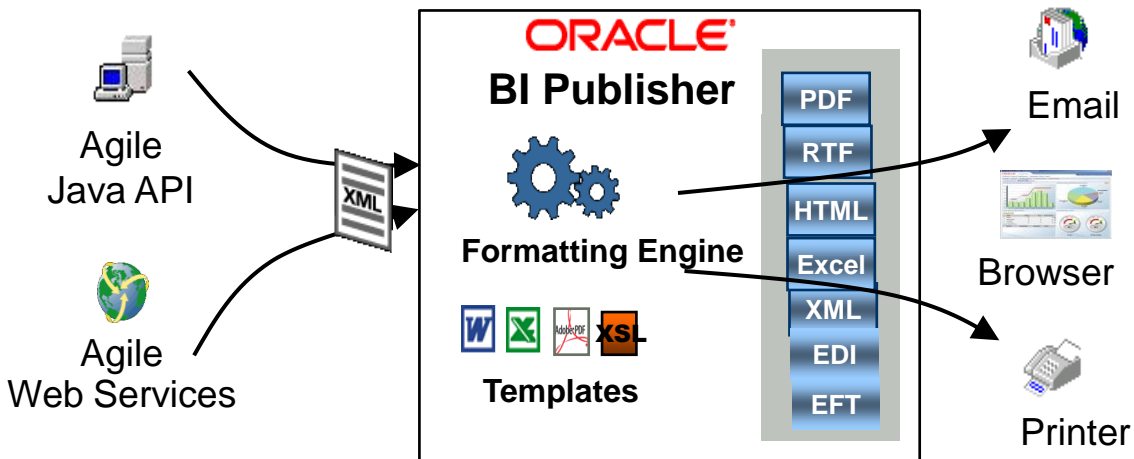

**Oracle BI Publisher**

**Oracle Fusion Middleware**

### Challenge

- Empower Agile customers to create their own functional reports & product documents (Datasheets & Manuals)

### Solutions

- Fusion Middleware: BI Publisher
- Applications: Agile
- Oracle BI Publisher is a standard-based reporting platform
- Combines existing Agile Report functionality with powerful publish and distribute capabilities of BI Publishers
- Agile Process Extension (Px) enables report and document generation using Agile & BI Publisher APIs

### Benefits

- Business consultants can customize the report and document templates using familiar desktop tools
- Simplifies report maintenance by separating data logic, layout and UI translation

# Enterprise Identity Management

## Using Identity Manager & Access Manager

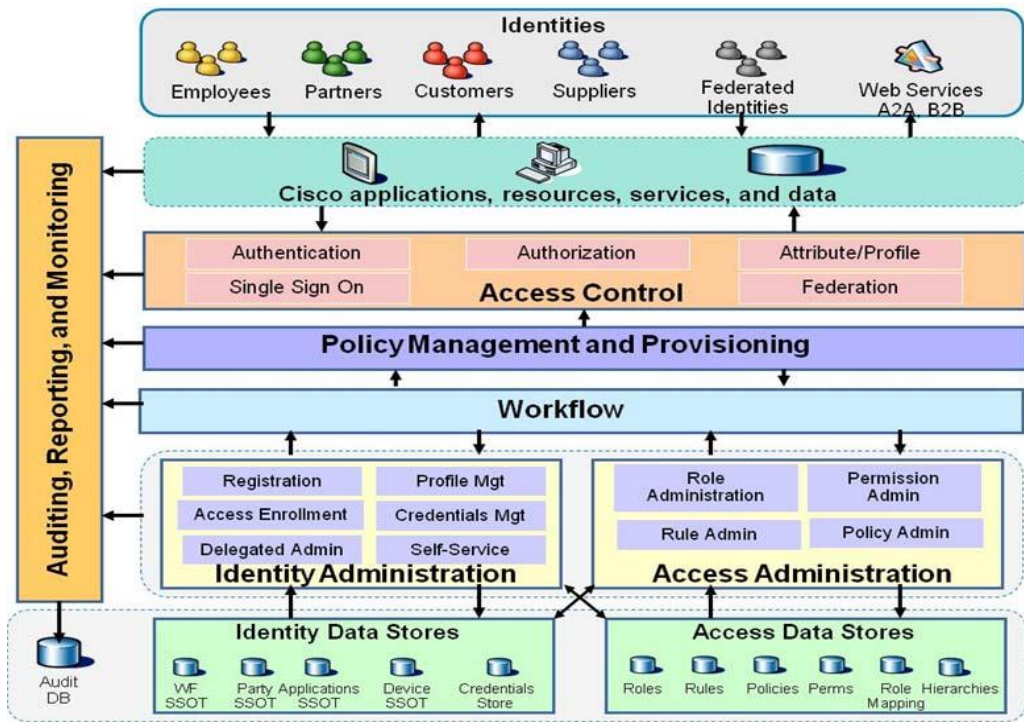

### Challenges

- Intellectual Property Protection and Security
- Business risk reduction, regulatory, legal, and corporate policy compliance

### Solutions

- Fusion Middleware: Identity Manager, Access Manager, (OAM) Internet Directory (OID)
- Application: All applications, Servers

Oracle Identity Manager, Internet Directory & Access Manager

Oracle Fusion Middleware

### Benefits

- Operational Efficiency & Cost Containment (e.g. reduce IT support costs)

ORACLE

# Agile Application Management Pack

## Using Oracle Enterprise Manager



IT Administrator

### Enterprise Manager Dashboard

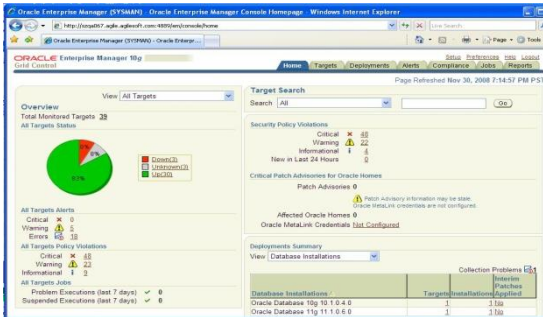

System Status

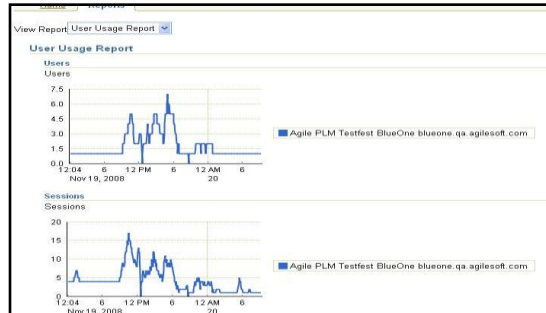

Agile Usage Reports

### Agile Deployment

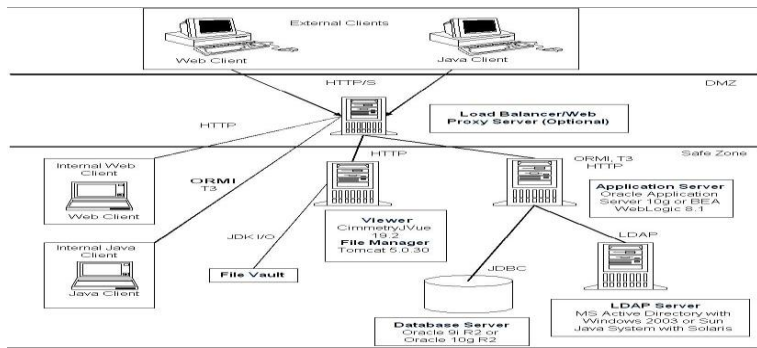

Oracle Enterprise Manager

Oracle Fusion Middleware

### Challenges

- Manage applications top-down, from the business perspective
- Manage entire application lifecycle to increase business agility

### Solutions

- Fusion Middleware: Enterprise Manager
- Applications: E-Business Suite, Siebel, JD Edwards, PeopleSoft, Agile, etc.
- Servers: All

- Enterprise Manager monitors health of Database, Application, File manager, LDAP, SSO and Web Servers and send alert to IT Administrators
- Agile Application management plug-in tracks user usage, application versions, application status and alerts

### Benefits

- Reduce IT Operation Costs

# Benefits

- Improve ROI of IT investments
  - Industry leading, open standards-based Fusion Middleware platform
- Extend value chain through Integrated PLM
  - CRM, ERP, CAD, BI, SCM
- Better alignment of business with technology
  - Model services to business requirements and needs
- Lower integration costs & complexity
  - Use platform-neutral technology infrastructure
- Empower business users
  - Better usability, Mobile applications, Web 2.0 Services



# Where do we find information?

## Agile Fusion Middleware Best Practice Center

- Oracle By Example (OBE):
  - Tutorials with step-by-step instructions
- Articles
  - Articles covering Agile and Fusion Middleware best practices and techniques
- Blogs
  - Blog entries from Oracle Experts & Partners
- Webcasts
  - Webcasts from Oracle Experts & Partners

<http://www.oracle.com/technology/tech/fmw4apps/agile/index.html>