

ORACLE®

ZFS STORAGE
APPLIANCE

Oracle ZFS Storage Appliance and Oracle's IT Environment: Use Cases and Benefits

ORACLE WHITE PAPER | MARCH 2017



ORACLE®



Table of Contents

Executive Overview	1
Introduction	2
Scope and Intent	4
Use Case Example: Mission-Critical OLTP Oracle Database and Patch Repository	4
Use Case Example: My Oracle Support Test/Dev Environment	7
Use Case Example: Logic and Circuit Simulation for Microprocessor Development	7
Use Case Example: Oracle Managed Cloud Services	7
Use Case Example: Oracle University	9
Use Case Example: Development of Service Solutions and Interop Testing	10
Use Case Example: IT Automation Tool	10
Use Case Example: Compute Farm for Software Development	11
Conclusion	13



Executive Overview

Oracle's broad IT organization handles an incredible volume of data across a vast spectrum of storage workloads. These workloads include everything from the storage of internal corporate email and collaborative workspaces to mission-critical databases and high-performance computing (HPC) environments supporting microprocessor development. Oracle's internal-facing IT business units must meet the IT needs of well over 100,000 employees, many of whom are engaged in software and hardware development activities. At the same time, Oracle's IT organization also manages Oracle's customer-facing cloud businesses as well as various internal-facing mission-critical databases. From a storage workload perspective, Oracle's IT environment is one of the most varied, demanding, and crucial environments imaginable. The Oracle ZFS Storage Appliance family of products serves Oracle's IT organization as an extremely versatile, high-performance storage platform—the ideal tool to meet the storage needs of this highly diverse and demanding IT environment. Today, Oracle has nearly 1 exabyte of storage on the Oracle ZFS Storage Appliance platform.

Introduction

Over the past few years, Oracle's IT organization has been working toward the standardization and consolidation of a wide variety of NAS workloads on the Oracle ZFS Storage Appliance platform, including mission-critical Oracle Database storage. In December 2016, Oracle's IT environment had nearly 1 exabyte of storage on the Oracle ZFS Storage Appliance platform. Thousands of database instances, over 33 billion database transactions per day, and more than 70 million users both inside and outside of Oracle run on the Oracle ZFS Storage Appliance platform. As part of Oracle's IT organization's ongoing initiative to transition from legacy storage systems (primarily from NetApp and EMC) and standardize on the Oracle ZFS Storage Appliance platform, significant performance and efficiency benefits have been realized. For instance, replacing EMC Symmetrix systems in a compute farm that supports application development produced a 12x performance increase. In another example, transaction times were slashed by between 23 percent and 66 percent in a mission-critical online transaction processing (OLTP) database used for gatekeeping and managing downloads from a patch repository. But these performance improvements are just a part of the story. Management efficiency benefits as a result of the Oracle ZFS Storage Appliance platform's advanced management interface, unprecedented analytics tools, and powerful scripting capabilities have enabled massive data expansion with nearly a 2:1 improvement in headcount per TB of data.

TABLE 1: ORACLE ZFS STORAGE APPLIANCE IN ORACLE'S IT ORGANIZATION: USE CASES AND BENEFITS

Use Case	Description	Highlights
Mission-Critical OLTP	Oracle Database is used for patches and updates and for the Oracle Software Delivery Cloud system.	This database handles more than six million requests and 400,000 patch downloads.
Development of Service Solutions and Interoperability Testing	An internal-facing group within the IT organization tests interoperability and develops solutions for Oracle Fusion Applications running on a variety of third-party servers and operating systems.	The Oracle ZFS Storage Appliance platform enables a combination of NFS shares and iSCSI LUNs that are used for the storage of the database workloads, virtual machine (VM) files, operating system (OS) images, and code changes that are being developed in a clone-based test/dev environment.
Oracle Managed Cloud Services	Oracle Managed Cloud Services (formerly Oracle On Demand) is a business within Oracle's IT organization that handles operation, administration, and management of customer-facing IT resources. It is responsible for the administration and management of a complete Oracle stack architecture in cloud deployments.	Customer cloud application offerings that reside on the Oracle ZFS Storage Appliance platform include Oracle E-Business Suite, Oracle Express, Oracle Email Center, Oracle iLearning, Oracle's Agile product lifecycle management applications, Oracle Beehive, Oracle's PeopleSoft product portfolio, Oracle's Siebel products, Oracle Hyperion enterprise performance management products, Oracle's JD Edwards EnterpriseOne products, and many others, including some third-party software offerings.
Compute Farm for Software Development	Oracle's IT organization supports internal software development activities by providing a large-scale, high-performance test/dev environment.	This environment, which is managed entirely by Oracle Enterprise Manager, uses 15,000 compute hosts to support development needs, while the Oracle ZFS Storage Appliance platform provides the storage for this environment.



From a product development and product improvement perspective, Oracle's IT environment provides one of the most demanding and comprehensive proving grounds. It has enabled Oracle's storage business to aggressively and continuously refine and improve the Oracle ZFS Storage Appliance family of products. Storage customers who select an Oracle ZFS Storage Appliance product instead of competing options do so with the confidence that the product has been rigorously designed for and proven in a plethora of the most demanding IT environments within Oracle.



Scope and Intent

The purpose of this paper is to highlight some interesting examples of the use of Oracle ZFS Storage Appliance systems within Oracle's IT organization and to document interesting reference architectures for those use cases. While it is hoped that this paper will serve as a good reference for Oracle ZFS Storage Appliance customers in terms of the suitability of these products for the various workloads contained herein, the particulars for the architecture implementations are intended to serve only as examples. Each organization has its own set of specific requirements and constraints that needs to be considered when architecting storage solutions. Oracle ZFS Storage Appliance systems are highly versatile and configurable, so most customers will find the products sufficiently flexible to meet their particular needs in a wide variety of scenarios.

Use Case Example: Mission-Critical OLTP Oracle Database and Patch Repository

An extremely compelling example of a mission-critical OLTP workload within Oracle's IT environment is the Oracle Database database used for patches and updates and the Oracle Software Delivery Cloud system. This system handles a variety of important tasks, including patch deployment to more than three million registered users. Each week, this database handles more than six million requests and 400,000 patch downloads.

The primary storage for both the database and the patch file repository associated with this system is an Oracle ZFS Storage Appliance cluster system with 10 GbE connectivity, 512 GB of DRAM, 12 solid-state drives (SSDs) for read cache, and eight 6-core processors. The eight disk shelves contain one hundred seventy-six 7,200 RPM SAS hard disk drives (HDDs) for storage and 16 SSDs for write cache. The entire database resides on two storage pools (one per head), each with four separate file systems for the following:

- » Log files with a 128 K record size and log cache device usage set to "metadata only" mode
- » Database data files with an 8 K record size
- » OCR/voting files (for Oracle Real Application Clusters [Oracle RAC]) with a 128 K record size
- » Patch repository files

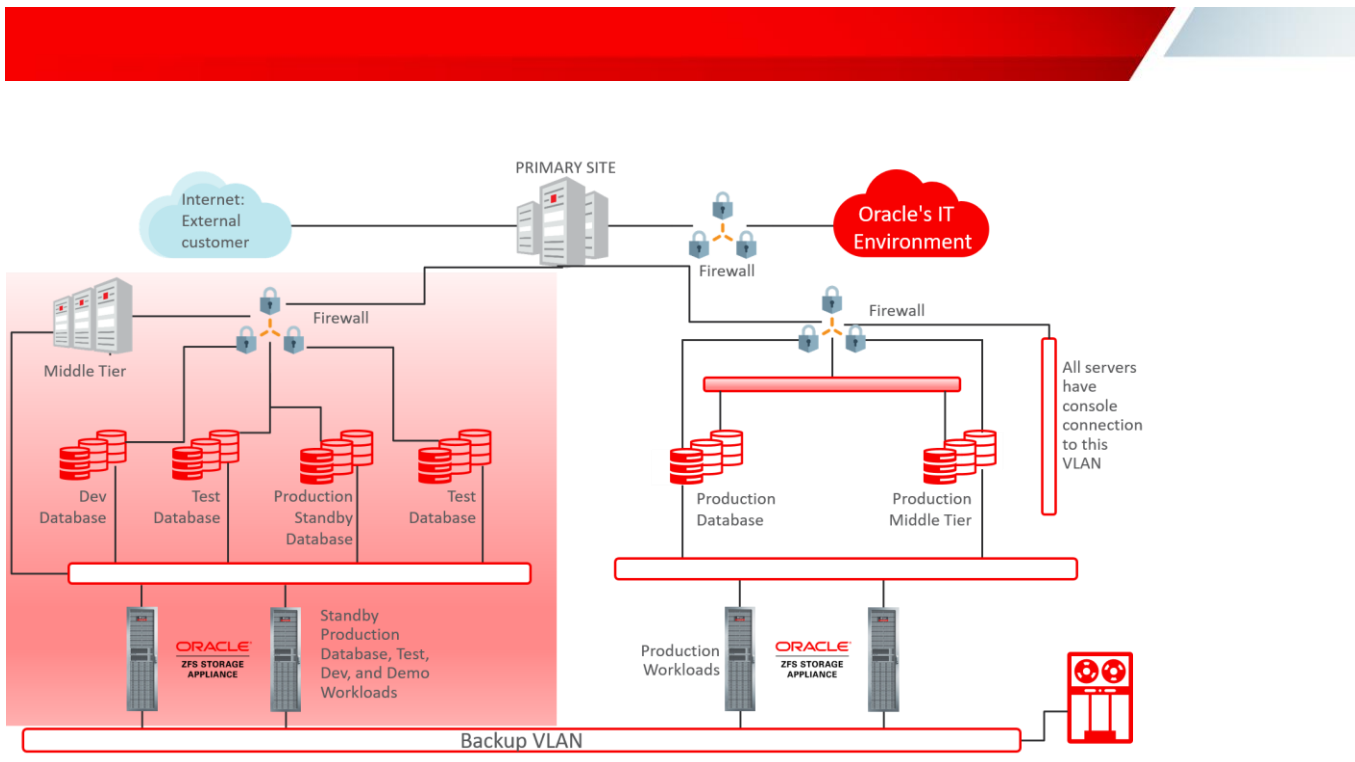

Figure 1. Oracle patches and updates and Oracle Software Delivery Cloud system primary site.

The NFS protocol is used for communication between Oracle Linux, the Oracle ZFS Storage Appliance systems, and the Oracle RAC server. LZJB compression is used for all file system mirroring for data protection in order to obtain optimal performance. LZJB reduces the footprint of the data significantly. LZJB compression requires less CPU overhead than other compression options, making it perfect for this performance-sensitive environment. In fact, in many cases, the use of LZJB actually enhances performance because it reduces throughput requirements through the back-end SAS interfaces.

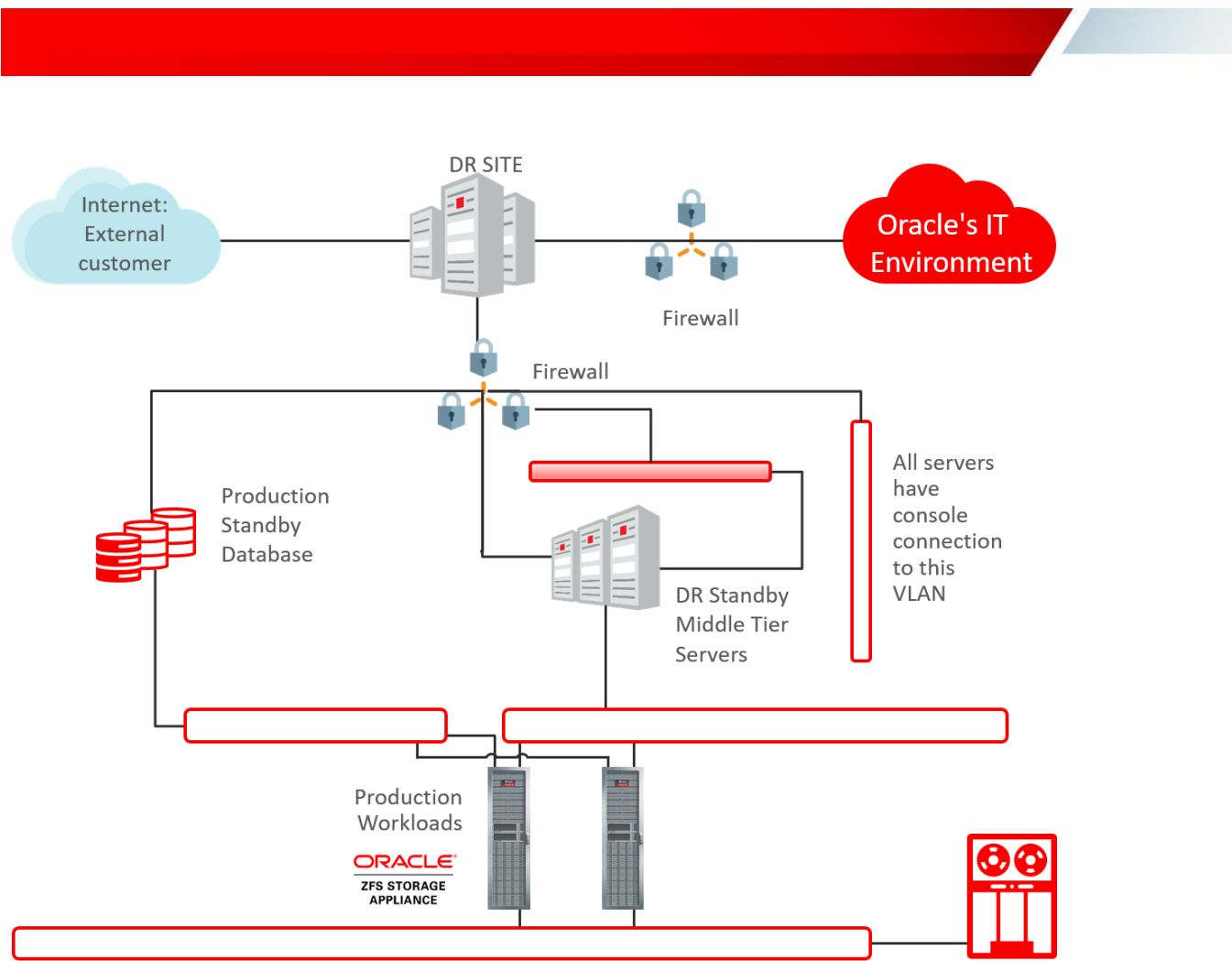

Figure 2. Oracle patches and updates and Oracle Software Delivery Cloud system disaster recovery site.

Oracle Active Data Guard software is used with the Oracle ZFS Storage Appliance platform's Replication feature to provide disaster recovery (DR) capability at a remote site. Oracle Active Data Guard is used to replicate the live production OLTP database, while remote replication (a capability of the Replication feature) is used to replicate the patch repository and Oracle Recovery Manager (Oracle RMAN) backup files to the remote site.

Snapshot and cloning data services are employed to facilitate 100 separate test/dev environments (on separate products from the Oracle ZFS Storage Appliance family) where any proposed changes to the system can be tried and refined before production implementation.

Prior to implementing the Oracle ZFS Storage Appliance environment, this database resided on EMC Clariion storage. Once that storage was replaced with Oracle ZFS Storage Appliance systems, the time required for all SQL transactions dropped significantly. The overall elapsed per-execution time dropped from between 23 percent to 66 percent, depending on the specific SQL transaction.

In addition to the performance improvements, significant efficiency improvements have been realized, as well. The database administrator noted an approximate 50 percent reduction in storage space that the database occupies due to the LJZB compression.

Migration from the EMC system to the Oracle ZFS Storage Appliance system was accomplished using Oracle Active Data Guard. The team was able to accomplish the entire transition with less than one hour of downtime.



This high-performance, mission-critical database is a great example of the applicability of the Oracle ZFS Storage Appliance systems to tier 1 enterprise environments as well as to related disaster recovery and test/dev environments. The high levels of performance, superb management tools with advanced analytics, and advanced data services make the Oracle ZFS Storage Appliance platform an ideal choice for this type of environment.

Use Case Example: My Oracle Support Test/Dev Environment

Many Oracle customers are familiar with the My Oracle Support system, which is Oracle's primary service and support portal for downloading updates and patches, and obtaining services as well as technical documentation and best practices for Oracle products. This system is being continuously expanded and improved as a part of general service improvement initiatives. In order to facilitate these ongoing development activities, a test/dev environment is employed that uses Oracle VM with 61 virtual servers to handle the application, middleware, and database stacks.

Storage for this Oracle VM-based test/dev environment is standardized on Oracle ZFS Storage Appliance systems. Snapshots and clones are employed to rapidly deploy workable "copies" of the production systems that occupy very little storage capacity—including the VM files themselves along with all of the application files. In this large-scale environment, the ability of the ZFS file system to support a virtually unlimited number of snapshots and clones is a compelling feature. This system allows a full test/dev environment to be up and running in about three hours. (Under the prior system that leveraged full copies, deploying a test/dev environment could take several days.)

The general setup for the storage is one pool per head, each with one project and several file systems. There are 61 file systems total, each corresponding to one of the 61 VMs, all of which can be cloned multiple times to support various test/dev instances. These 61 base file systems contain all of the Oracle VM virtual server files, along with all of the OS, database, and application files that are necessary to support a test/dev instance upon cloning. All pools are either triple-mirrored or double-mirrored, depending on the level of criticality. LZJB compression is employed with a 128 K record size for all file systems. All systems are high availability (HA) clusters with NSPF and use 7,200 RPM drives. The NFS protocol and 10 GbE connectivity are employed.

Use Case Example: Logic and Circuit Simulation for Microprocessor Development

Oracle's IT organization manages a dedicated facility that handles the HPC requirements for Oracle's SPARC processor design. This facility employs Oracle ZFS Storage Appliance systems to handle the storage needs of the microprocessor development teams. They use a number of Oracle ZFS Storage Appliance systems of varying configurations, but all have 7,200 RPM HDDs and employ the NFS protocol via 10 GbE connectivity. Most systems also have mirrored write cache SSDs except for a few that experience read workloads almost exclusively. For optimal performance, mirroring is used for data protection, and LZJB compression is used to reduce footprint and increase back-end SAS effective throughput. Compared to NetApp systems, Oracle ZFS Storage Appliance systems provide ample CPU capacity and large memory with efficient in-memory read caching, which allow for the use of the cost-effective, less energy-hungry 7,200 RPM HDDs.

Use Case Example: Oracle Managed Cloud Services

Oracle Managed Cloud Services (formerly Oracle On Demand) is a business within Oracle's IT organization that handles operation, administration, and management of customer-facing IT resources. It is responsible for the administration and management of a complete Oracle stack architecture in cloud deployments.



Oracle Managed Cloud Services uses Oracle ZFS Storage Appliance systems extensively for mission-critical storage for this environment. Cloud application offerings that reside on Oracle ZFS Storage Appliance systems include Oracle E-Business Suite, Oracle Express, Oracle Email Center, Oracle iLearning, Oracle's Agile product lifecycle management applications, Oracle Beehive, Oracle's PeopleSoft product portfolio, Oracle's Siebel products, Oracle Hyperion enterprise performance management products, Oracle's JD Edwards EnterpriseOne products, and many others, including some third-party software offerings.

This Oracle Managed Cloud Services infrastructure consists of more than 17,000 VMs running on more than 4,000 physical servers. Storage for the environment is NFS, and more than 5,300 customer instances representing more than 2,400 customers now utilize Oracle ZFS Storage Appliance systems for their storage infrastructures. The typical customer environment involves a complete software stack, from the OS level (Oracle Linux or Oracle Solaris) with Oracle Database (including Oracle RAC, in some cases) to Oracle Fusion Middleware and Oracle Fusion Applications running on top. Each customer gets his or her own VM or physical server, but storage for multiple customers may be consolidated on Oracle ZFS Storage Appliance systems via the NFS protocol and 10 GbE infrastructure. To ensure complete customer isolation and security, Oracle VM machine files and OS files for any given customer are compartmentalized, and storage access is controlled at the file system level. This allows multitenancy on the Oracle ZFS Storage Appliance systems while preventing data access across customer accounts.

Storage for databases, middleware, and individual applications is segregated from one another and from VM files and OS storage by project to optimize performance and speed deployment. Separate file systems are used for different data types to segregate. For example, the database log file is segregated from database data files and from the application files themselves. Project and file system settings on the Oracle ZFS Storage Appliance systems are highly customizable, allowing great flexibility to optimally tune for a variety of environments. A project dedicated to Oracle E-Business Suite might include the following shares:

- » Oracle Database data files
- » Oracle Database index files
- » Oracle Database temporary tablespace files
- » Oracle Database backup files
- » Oracle Database redo log files
- » Oracle Fusion Middleware product files
- » Application product code tree
- » Application log and temp files

Storage of database data files for the enterprise resource planning (ERP) system will use an 8 K record size setting at the file system level whereas the database log file settings under the same project will use the project's default 128 K record size in a separate file system. In that same project, there will be other file systems for the application files that run the ERP system application itself, which inherit the project's default 128 K record size.

All Oracle ZFS Storage Appliance systems involved in this environment are HA cluster configurations and are set up with NSPF. All use mirrored write flash accelerator devices and striped read flash cache devices. The extensive processor power and DRAM scalability of Oracle ZFS Storage Appliance systems allows the attachment of a large number of disk spindles, and typically 7,200 RPM SAS HDDs are used for back-end storage. In certain database instances with extremely high-performance requirements under random I/O, 15,000 RPM SAS drives are employed. Mirroring is used for data protection in order to achieve optimal performance, and triple mirroring is used in some cases for higher redundancy data protection.



Backup and archive for the production environment is accomplished using NDMP from the Oracle ZFS Storage Appliance systems to an Oracle Secure Backup server and ultimately on to tape. Many customers also elect to have a remote DR site. For DR of Oracle Database, Oracle Active Data Guard is used to replicate the live database to the remote storage via the database server. DR for patch repositories, scripts, and application files is accomplished using remote replication as a storage data service in the Oracle ZFS Storage Appliance systems.

Prior to the adoption of Oracle ZFS Storage Appliance systems, the Oracle Managed Cloud Services business relied primarily on NetApp filers. Throughout the ongoing migration process, many benefits of the Oracle ZFS Storage Appliance systems have been realized. By leveraging the superior performance and management efficiency benefits along with the industry's best storage analytics environment (through DTrace Analytics, which is a feature of Oracle ZFS Storage Appliance systems), overall performance has improved while operating expenses associated with management time have decreased. In fact, one recent study within Oracle's IT organization found nearly a 2:1 improvement in headcount/GB efficiency after a major storage upgrade replacing NetApp systems with Oracle ZFS Storage Appliance systems.

The storage analytics offer unprecedented visibility to help resolve bottlenecks to optimize system performance quickly, particularly in this extensive VM environment, compared to what competing options would offer. For example, if a client were to experience slow performance, DTrace Analytics would allow the storage admin to determine quickly if the bottleneck is related to storage or if it is an issue related to client tuning. Unlike with competing analytics packages, it is possible with DTrace Analytics to drill down easily from the physical interface level through the entire storage stack all the way to the file or disk level.

Migration from NetApp to Oracle ZFS Storage Appliance systems has been ongoing and is now nearing completion. Moving an environment of this scale and complexity is obviously a significant undertaking that takes time. Fortunately, NFS migration to Oracle ZFS Storage Appliance systems has been made as straightforward and unobtrusive as possible by the use of the Shadow Migration feature.

Use Case Example: Oracle University

Another interesting workload is the Oracle University infrastructure. Oracle University provides both internal and customer training and education services. It uses databases and content streaming to provide an interactive, online training experience. This is a critical system because it is externally available and customer facing—it must remain online at all times in order to support the training requirements of Oracle customers and employees around the world. This system used to be run with NetApp filers, but now it runs with an Oracle ZFS Storage Appliance system, along with a second similar system at a DR site where Oracle ZFS Storage Appliance software's remote replication capability is used to move the data. The Oracle ZFS Storage Appliance system consists of HA clusters with NSPF and one storage pool per head. They are set up with mirroring as data protection. File systems typically use LZJB compression with the default 128 K record size. The Oracle Database data file shares are the exception; they use an 8 K record size. Since transitioning from NetApp, performance has increased significantly, while the compression enables a smaller storage footprint.

Shadow Migration was used to perform the migration seamlessly from NetApp with minimal downtime. Shadow Migration is a feature of the Oracle ZFS Storage Appliance system that allows it to serve as primary storage while simultaneously moving data from a third-party NFS-capable NAS system, such as NetApp.

This workload is interesting because the storage must provide a high-performance, HA interactive streaming content experience in the form of 41,000 classes to more than 350,000 students across the globe annually. Any customer interested in any type of streaming media workload consolidated with database storage can be assured that the Oracle ZFS Storage Appliance system has proven itself in one of the most rigorous environments of this type.

Use Case Example: Development of Service Solutions and Interop Testing

An internal-facing group within Oracle's IT organization tests interoperability and develops solutions for Oracle Fusion Applications running on a variety of third-party servers and operating systems. Each environment runs an OS on either a physical server or a VM that has three Oracle Database databases—one that is transactional and two for identity management. More than 50 Oracle WebLogic Server instances are used to develop application changes or are patched for apps such as Oracle Business Intelligence Suite, Oracle Access Manager, and Oracle Fusion Applications. The storage for this environment is provided primarily by Oracle ZFS Storage Appliance systems via a 10 GbE environment. A combination of NFS shares and iSCSI LUNs are used for the storage of the database workloads, VM files, and OS images, and for code changes that are being developed in a clone-based test/dev environment. This group's charter is to resolve current customer issues as needed and deploy patches or application changes rapidly to support the service organization, making storage performance and availability critical.

Use Case Example: IT Automation Tool

Oracle has an IT automation tool that is used by both internal and external parties to assist in infrastructure management. This tool gives information about the devices on which applications are running and provides monitoring tools along with a change-approval process complete with user rules and roles. The IT automation tool is linked with the access-provisioning system to gain access to a single source for user rules and roles. Storage for this environment is consolidated on Oracle ZFS Storage Appliance systems.

The compute environment consists of hundreds of VMs. Storage for this environment runs on multiple Oracle ZFS Storage Appliance systems using a 10 GbE infrastructure and NFS to mount the VMs. NFS is also used for the file shares for the applications that run on the VMs. VM clients of the storage run primarily Oracle Linux instances within the Oracle VM hypervisor.

Some VM clients also support specific legacy systems running VMware or Oracle VM VirtualBox and Microsoft Windows Server 2008/2012 instances. The Oracle ZFS Storage Appliance systems are HA clusters with NSPF and one storage pool per head. They are set up with mirroring and data protection. Most projects use LZJB compression with the default 128 K record size. The Oracle Database data file shares are the exception; they use an 8 K record size. The remote replication capability is used to replicate to a DR site.

Many advantages were realized by migrating to the Oracle ZFS Storage Appliance systems from NetApp. First, superior performance was obtained compared with competing products. The performance advantage is due to the variable block sizes, mirroring as a data protection option, large flash-based cache, and high-performance controller hardware. The superior management tools, including the advanced browser user interface and DTrace Analytics package, simplify and speed management, maintenance, and deployment activities, all of which reduce effective operating costs over time. The analytics package allows unprecedented visibility into performance bottlenecks, including visibility into the storage network stack, which is particularly helpful in optimizing and troubleshooting large-scale VM environments.

Additionally, a comprehensive scripting interface is leveraged to develop standardized workflows to automate repetitive tasks. In some cases, these scripts even involve user inputs of basic parameters but still can run entirely from the appliance itself in an automated fashion. This advanced scripting functionality reduces complexity and cost by eliminating the need found in many non-Oracle storage environments to have centralized administration hosts that are dedicated to executing scripts for users. The Oracle ZFS Storage Appliance systems' Shadow Migration feature makes migrating from other NFS-capable systems straightforward and seamless, minimizing downtime requirements for transitions.

Use Case Example: Compute Farm for Software Development

Oracle's IT environment supports internal software development activities by providing a large-scale, high-performance test/dev environment. This environment, which is managed entirely by Oracle Enterprise Manager, uses 15,000 compute hosts to support development needs, while Oracle ZFS Storage Appliance systems provides the storage for this environment. This model enables parallel processing of builds and tests and offloads local development and QA systems. It creates a test baseline as part of the label creation process. (A label, as used here, is defined as a string, a set of files, or a snapshot of a development process at any given point in time.) It includes both static and dynamic farm systems and has a capacity of 350,000 compute hours per day and can complete 180,000 farm jobs per day. The farm is kept busy by global development on a 24/7 basis—even on weekends, the queue is rarely less than 20,000 jobs.

Within the dynamic farm, one of the main goals is to be able to shift between VM images for 1,500 VMs quickly. The storage for the VM images (mostly Oracle Linux and some Microsoft Windows) and OS files resides on an Oracle ZFS Storage Appliance system.

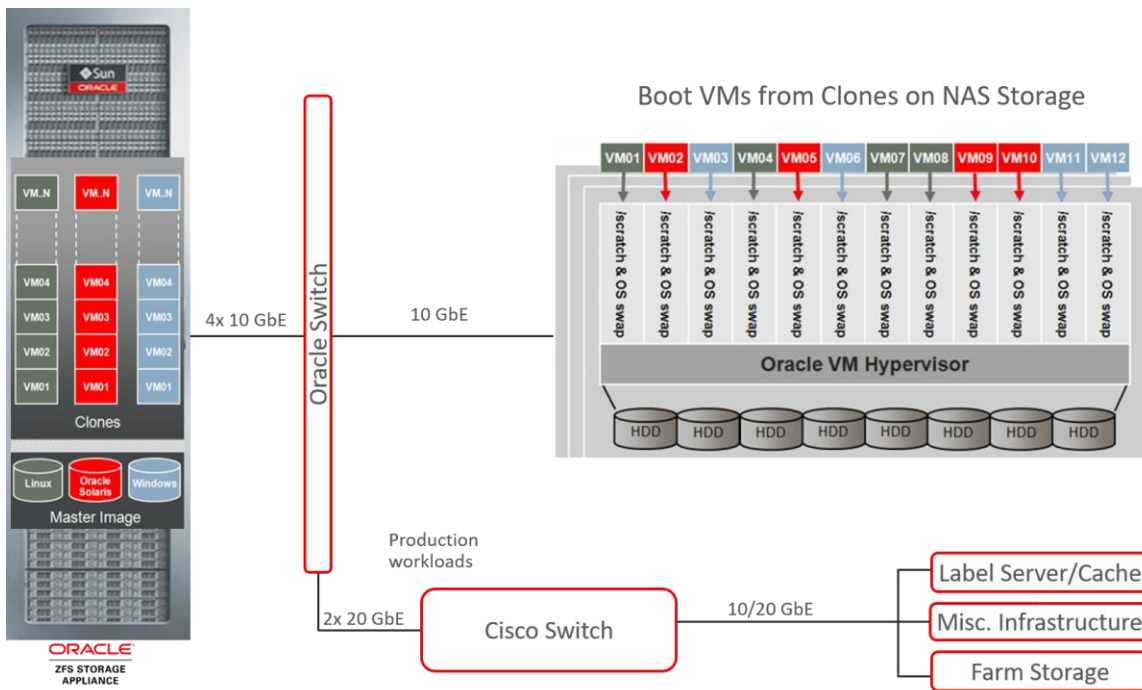

Figure 3. Compute farm architecture.

Clones are used to replicate base images from an image repository project to the live VM project. Scripting is used extensively to automate tasks for efficiency and consistency. In order to facilitate prerelease compute starvation and postrelease compute availability, there are separate input Oracle ZFS Storage Appliance systems from which application code is drawn and output Oracle ZFS Storage Appliance systems outside of the dynamic farm where development products are placed. This is all accomplished with NFS storage on an Ethernet-based infrastructure.

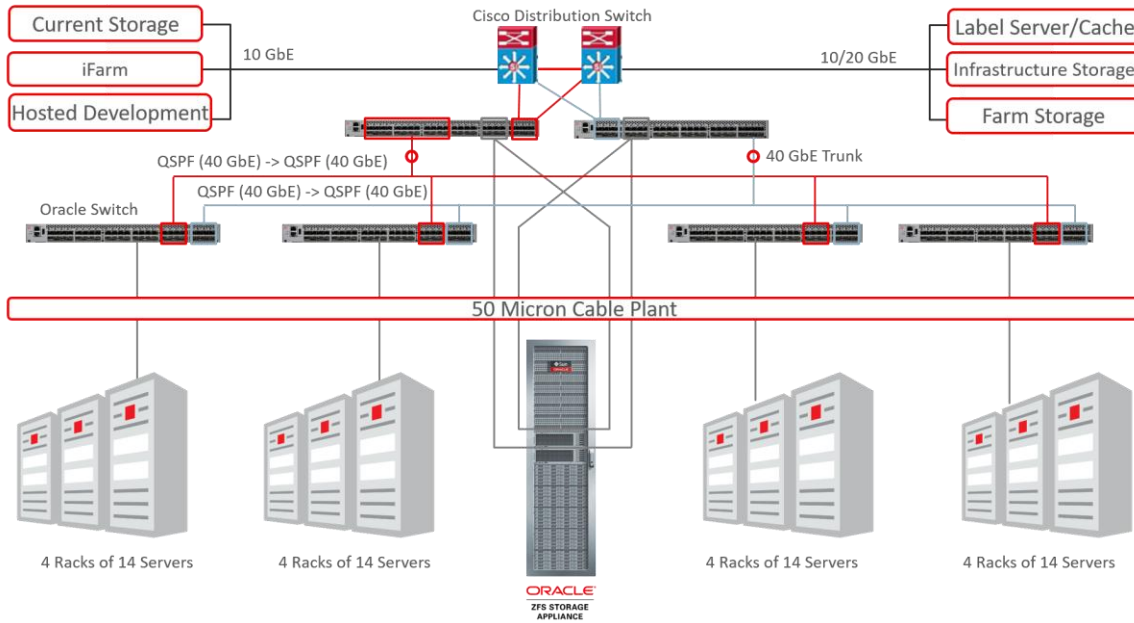

Figure 4. Dynamic farm architecture.

To date, more than 350 NetApp filers and 70 EMC arrays have been replaced in this environment with Oracle ZFS Storage Appliance systems. With the replacements, Oracle's IT organization found that approximately four NetApp filers could be replaced by one Oracle ZFS Storage Appliance system, due to the performance and compression advantages of Oracle ZFS Storage Appliance systems. Oracle's IT organization realized approximately an 8:1 disk consolidation ratio, and performance increased to about 191,000 IOPS by going to the Oracle ZFS Storage Appliance systems.



Conclusion

Oracle's IT organization is nearing the completion of a successful transition to using Oracle ZFS Storage Appliance systems in place of storage from a variety of storage vendors. This transition process has been aided by Oracle tools such as Oracle Active Data Guard for Oracle Database and by the Shadow Migration feature of Oracle ZFS Storage Appliance systems. Oracle's IT organization has realized enormous benefits since upgrading its storage infrastructure to Oracle ZFS Storage Appliance systems. Performance has improved markedly, sometimes many times over the incumbent systems, as a result of the Oracle ZFS Storage Appliance systems' powerful hardware and intelligent Hybrid Storage Pool data management technology. Efficiency has improved significantly as well, both in terms of storage capacity efficiency as a result of LZJB compression and in terms of management efficiency as a result of the advanced management interface, powerful analytics, sophisticated scripting language, and deep Oracle stack integration. In fact, headcount per TB of storage managed has improved by nearly a 2:1 factor in some areas. These performance and efficiency advantages are apparent across a wide variety of storage workloads, including mission-critical OLTP databases, massive software test/dev environments, and VM environments for Oracle's customer-facing cloud businesses.

While the Oracle ZFS Storage Appliance family of products serves Oracle's IT organization beautifully, Oracle's IT organization also serves Oracle ZFS Storage Appliance systems by providing one of the most rigorous and varied product proving grounds imaginable. For customers considering a move to an Oracle ZFS Storage Appliance product, Oracle's own IT operations substantiate that selecting an Oracle ZFS Storage Appliance system is appropriate even for the most demanding storage workloads.







Oracle Corporation, World Headquarters

500 Oracle Parkway
Redwood Shores, CA 94065, USA

Worldwide Inquiries

Phone: +1.650.506.7000
Fax: +1.650.506.7200

CONNECT WITH US

-  blogs.oracle.com/oracle
-  facebook.com/oracle
-  twitter.com/oracle
-  oracle.com

Integrated Cloud Applications & Platform Services

Copyright © 2017, Oracle and/or its affiliates. All rights reserved. This document is provided *for* information purposes only, and the contents hereof are subject to change without notice. This document is not warranted to be error-free, nor subject to any other warranties or conditions, whether expressed orally or implied in law, including implied warranties and conditions of merchantability or fitness for a particular purpose. We specifically disclaim any liability with respect to this document, and no contractual obligations are formed either directly or indirectly by this document. This document may not be reproduced or transmitted in any form or by any means, electronic or mechanical, for any purpose, without our prior written permission.

Oracle and Java are registered trademarks of Oracle and/or its affiliates. Other names may be trademarks of their respective owners.

Intel and Intel Xeon are trademarks or registered trademarks of Intel Corporation. All SPARC trademarks are used under license and are trademarks or registered trademarks of SPARC International, Inc. AMD, Opteron, the AMD logo, and the AMD Opteron logo are trademarks or registered trademarks of Advanced Micro Devices. UNIX is a registered trademark of The Open Group. 0317

Oracle ZFS Storage Appliance and Oracle's IT Environment: Use Cases and Benefits
March 2017

Author: Bryce Cracco

Contributing Authors: Matthew Barnson, Patricio Zambrano, Gary Burch, Priyobrato Chatterjee, Robert Lashley, Ryan MacDonald, Chris W. Martin, Torrey McMahon, Ryan Mikuni, Erik Neilsen, Andres Noriega, Jaideep Paidimari, Gowthaman Ranganathan, and Burra Sarma